

člen **Makita** Group

**DOLMAR**

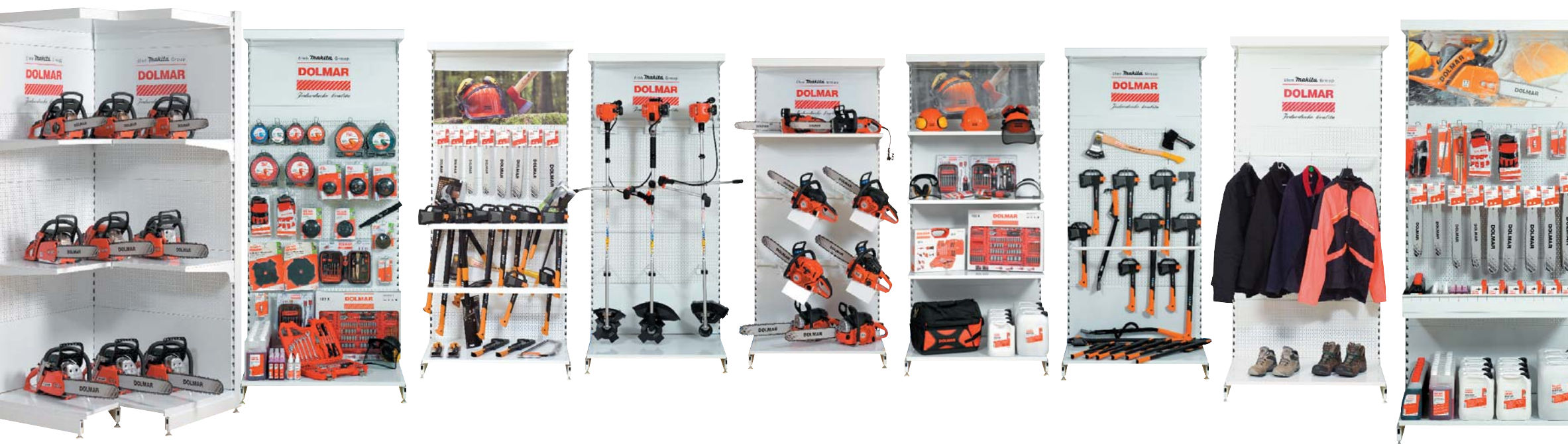

*Jednoduše kvalita*



# ÚPLNÝ KATALÓG PRÍSLUŠENSTVA DOLMAR 2017/2018

# obsah

**DOLMAR**



## **Píly**

Reťaze pre elektrické a vyvetvovacie píly . . . . .	4
Lišty pre elektrické a vyvetvovacie píly . . . . .	5
Lišty so španovákcom pre elektrické píly . . . . .	6
Reťaze pre benzínové píly . . . . .	7–11
Lišty pre benzínové píly . . . . .	12–16
Lišty PowerMatch . . . . .	17
RescueCut . . . . .	18–19
Vzduchové filtre pre benzínové píly . . . . .	20–23
Pilníky . . . . .	24–26
Rolky reťazí . . . . .	27
Brúsky na ostrenie reťazí . . . . .	28–29
Kombinované kľúče . . . . .	30
Zapaľovacie sviečky . . . . .	31
Kanistre . . . . .	32
Kryty líšt . . . . .	33
Kufre . . . . .	34

## **Oleje**

Oleje . . . . .	36–39
-----------------	-------

## **Krovinorezy**

Žacie lanká . . . . .	42–45
Žacie hlavy . . . . .	46–47
Žacie nože . . . . .	48–49
Kryty žacích hláv a nožov . . . . .	50–51
Popruhy . . . . .	52–53
Náhradné diely pre žacie hlavy . . . . .	54–58
Nadstavce, držadlá . . . . .	59–62

## **Kosačky**

Žacie nože pre elektrické kosačky . . . . .	64–65
Žacie nože pre benzínové kosačky . . . . .	66–67
Mulčovacie klíny pre elektrické kosačky . . . . .	68–69
Mulčovacie klíny pre benzínové kosačky . . . . .	70–71
Nože pre vertikátory a kultivátory . . . . .	72–73

## **Traktory**

Mulčovacie klíny . . . . .	76–77
Žacie nože . . . . .	78–79
Mulčovacie nože, sady . . . . .	80–81
Zametacia kefa, príves, pluh, príslušenstvo . . . . .	82–89

## **Vysokotlakové čističe**

Hadice, trysky, kefy, filtre . . . . .	92–97
--	-------

## **Akumulátorové Li-Ion náradie**

Reťaze pre akku píly . . . . .	100
Lišty pre akku píly . . . . .	101
Nože pre aku krovinorezy, žacie hlavy . . . . .	102
Žacie nože, pre kosačky/kultivátory, popruhy . . . . .	103
Nože pre aku plotostrihy . . . . .	104
Aku dúchadlá, postrekovače . . . . .	105
Akumulátory, nabíjačky . . . . .	106–107

## **Ostatné**

Žacie nože pre plotostrihy . . . . .	110–111
PD-520 R . . . . .	112–113
MP-352,4, WK-80, PB-250.4, PB-252.4 . . . . .	114
Štiepače, rosiče . . . . .	115
Predlžovačky, pílové kotúče . . . . .	116
Štvortaktný postrekovač . . . . .	117
Klíny . . . . .	118–119
Háky, pásma, spreje, sady príslušenstva . . . . .	120–123
Prilby, sieťky, rukavice, oblečenie . . . . .	124–137

## **Promo**

Stojany, vlajky, Promo . . . . .	140–146
----------------------------------	---------

## **Servisné náradie**

Servisné náradie . . . . .	148–151
Nastavenia píl . . . . .	152–153
Balenia olejov . . . . .	154–155
Balenia žacích lánk . . . . .	156–157
Typy reťazí . . . . .	158

## **Regálové vybavenie predajní**

Regálové vybavenie predajní . . . . .	160–199
---------------------------------------	---------



Pily

# reťaze PRE ELEKTRICKÉ PÍLY



pre elektrické píly

			Dĺžka lišty	Delenie pílovej reťaze	Šírka drážky	Profil zubu	Objednávacie číslo	MOC EUR s DPH
	ES-31 A, ES-33 A	ES-34 TLC	30 cm/12"	3/8"	1,1 mm	HM	958 291 046	<b>10,33 €</b>
	ES-36 A, ES-38 A	ES-39 TLC	35 cm/14"	3/8"	1,1 mm	HM	958 291 052	<b>11,78 €</b>
	ES-40 A, ES-42 A	ES-43 TLC	40 cm/16"	3/8"	1,1 mm	HM	958 291 056	<b>12,17 €</b>
	ES-40 A, ES-42 A	ES-43 TLC	40 cm/16"	3/8"	1,3 mm	HM	511 492 756	<b>12,35 €</b>
	ES-2030 A, ES-2130 A	ES-2131 TLC	30 cm/12"	3/8"	1,3 mm	HM	958 492 046	<b>10,90 €</b>
	ES-2035 A, ES-2135 A	ES-2136 TLC	35 cm/14"	3/8"	1,3 mm	HM	958 492 052	<b>12,13 €</b>
	ES-2040 A, ES-2140 A	ES-2141 TLC	40 cm/16"	3/8"	1,3 mm	HM	958 492 056	<b>13,38 €</b>
	ES-2045A	ES-2145 A	45 cm/18"	3/8"	1,3 mm	HM	511 492 762	<b>12,40 €</b>

pre elektrické vyvetvovacie píly

		Dĺžka lišty	Delenie pílovej reťaze	Šírka drážky	Profil zubu	Objednávacie číslo	MOC EUR s DPH
	EE-150	25 cm/10"	3/8"	1,1 mm	HM	511 290 739	<b>11,45 €</b>



# lišty PRE ELEKTRICKÉ PÍLY



pre elektrické píly

			Dĺžka lišty	Delenie pílovej reťaze	Šírka drážky	Objednávacie číslo	MOC EUR s DPH
	ES-31 A, ES-33 A	ES-34 TLC	30 cm/12"	3/8"	1,1 mm	958 400 001	<b>11,21 €</b>
	ES-36 A, ES-38 A	ES-39 TLC	35 cm/14"	3/8"	1,1 mm	958 400 002	<b>12,27 €</b>
	ES-40 A, ES-42 A	ES-43 TLC	40 cm/16"	3/8"	1,1 mm	442 040 611	<b>13,58 €</b>
	ES-40 A, ES-42 A	ES-43 TLC	40 cm/16"	3/8"	1,3 mm	958 500 051	<b>12,96 €</b>
	ES-2030 A, ES-2130 A	ES-2131 TLC	30 cm/12"	3/8"	1,3 mm	958 500 003	<b>11,55 €</b>
	ES-2035 A, ES-2135 A	ES-2136 TLC	35 cm/14"	3/8"	1,3 mm	958 500 002	<b>11,88 €</b>
	ES-2040 A, ES-2140 A	ES-2141 TLC	40 cm/16"	3/8"	1,3 mm	958 500 051	<b>12,96 €</b>
	ES-2045 A	ES-2145 A	45 cm/18"	3/8"	1,3 mm	412 045 661	<b>13,51 €</b>

pre elektrické vyvetvovacie píly

		Dĺžka lišty	Delenie pílovej reťaze	Šírka drážky	Objednávacie číslo	MOC EUR s DPH
	EE-150	25 cm/10"	3/8"	1,1 mm	360 308 940	<b>63,91 €</b>

# lišty

SO ŠPANOVÁKOM PRE ELEKTRICKÉ PÍLY







			Dĺžka lišty	Delenie pílovej reťaze	Šírka drážky	Objednávacie číslo	MOC EUR s DPH
	ES-31 A, ES-33 A	ES-34 TLC	30 cm/12"	3/8"	1,1 mm / 0.043"	412 030 211	<b>17,46 €</b>
	ES-36 A, ES-38 A	ES-39 TLC	35 cm/14"	3/8"	1,1 mm / 0.043"	412 035 211	<b>15,18 €</b>
	ES-40 A, ES-42 A	ES-43 TLC	40 cm/16"	3/8"	1,3 mm / 0.050"	958 400 007	<b>15,64 €</b>



# reťaze

PRE BENZÍNOVÉ PÍLY



			Dĺžka lišty	Delenie pílovej reťaze	Šírka drážky	Profil zubu	Objednávacie číslo	MOC EUR s DPH
	PS-220 TH PS-221 TH		25 cm/10"	1/4"	1,3 mm	HM	512 466 760 *	<b>16,11 €</b>
			30 cm/12"	1/4"	1,3 mm	HM	512 466 768 *	<b>16,31 €</b>
			35 cm/14"	1/4"	1,3 mm	HM	512 466 776 *	<b>18,17 €</b>
			25 cm/10"	3/8"	1,3 mm	HM	511 492 740	<b>9,71 €</b>
		PS-311 TH	30 cm/14"	3/8"	1,3 mm	HM	511 492 746	<b>11,28 €</b>
	PS-32 C/TLC		30 cm/12"	3/8"	1,1 mm	HM	511 291 746	<b>10,26 €</b>
			35 cm/14"	3/8"	1,1 mm	HM	511 291 752	<b>11,62 €</b>
			30 cm/12"	3/8"	1,3 mm	HM	958 492 046	<b>10,90 €</b>
			35 cm/14"	3/8"	1,3 mm	HM	958 492 052	<b>12,13 €</b>
			40 cm/16"	3/8"	1,3 mm	HM	511 492 756	<b>12,35 €</b>
	PS-33, PS-34, 100,103, PS-340, PS-350 C, PS-400, PS-401, 100 s, 105, PS-400, PS-401, 102,108, PS-45	PS-35 C/TLC PS-310 TH PS-3410TH PS-350 SC PS-352 / TLC	30 cm/12"	3/8"	1,3 mm	HM	958 492 046	<b>10,90 €</b>
			35 cm/14"	3/8"	1,3 mm	HM	958 492 052	<b>12,13 €</b>
			40 cm/16"	3/8"	1,3 mm	HM	958 492 056	<b>13,38 €</b>
	PS-3410 TH		30 cm/12"	1/4"	1,3 mm	HM	512 466 768 **	<b>16,31 €</b>
			35 cm/14"	1/4"	1,3 mm	HM	512 466 776 **	<b>18,17 €</b>

VM = hranatý profil zubu

HM = guľatý profil zubu

\* záberové kolo obj. č. 320 165 405 1/4"

\*\* záberové kolo obj. č. 170 223 201 1/4"

# reťaze

PRE BENZÍNOVÉ PÍLY



			Dĺžka lišty	Delenie pílovej reťaze	Šírka drážky	Profil zubu	Objednávacie číslo	MOC EUR s DPH
	PS-410, PS-411, PS-420 C	PS-420 SC	33 cm/13"	0.325"	1,3 mm	HM	512 484 756	<b>12,06 €</b>
			38 cm/15"	0.325"	1,3 mm	HM	512 484 764	<b>13,86 €</b>
			45 cm/18"	0.325"	1,3 mm	HM	512 484 772	<b>15,23 €</b>

			Dĺžka lišty	Delenie pílovej reťaze	Šírka drážky	Profil zubu	Objednávacie číslo	MOC EUR s DPH
	109, 109HS, 111, 112, 117	PS-460 PS-500/C PS-550	38 cm/15"	3/8"	1,5 mm	HM	523 093 756	<b>14,06 €</b>
			45 cm/18"	3/8"	1,5 mm	HM	523 093 764	<b>15,01 €</b>
			53 cm/21"	3/8"	1,5 mm	HM	523 093 772	<b>16,70 €</b>

			Dĺžka lišty	Delenie pílovej reťaze	Šírka drážky	Profil zubu	Objednávacie číslo	MOC EUR s DPH
	110, 110i, 110iH, 115i	PS-460 PS-500/C PS-550 115, 111, PS-6100	33 cm/13"	0.325"	1,5 mm	HM	528 086 756	<b>11,94 €</b>
			38 cm/15"	0.325"	1,5 mm	HM	958 086 064	<b>14,71 €</b>
			40 cm/16"	0.325"	1,5 mm	HM	528 086 766	<b>19,05 €</b>
			45 cm/18"	0.325"	1,5 mm	HM	958 086 072	<b>16,48 €</b>

			Dĺžka lišty	Delenie pílovej reťaze	Šírka drážky	Profil zubu	Objednávacie číslo	MOC EUR s DPH
	110, 115i, 115iH 116, 116 si 120, 120 si PS-5000 PS-5000 H PS-4600 S PS-4605	115 PS-5105/C PS-6100	38 cm/15"	3/8"	1,5 mm	VM	958 099 056	<b>15,15 €</b>
			45 cm/18"	3/8"	1,5 mm	VM	958 099 064	<b>17,91 €</b>
			53 cm/21"	3/8"	1,5 mm	VM	528 099 772	<b>17,73 €</b>
			53 cm/21"	3/8"	1,5 mm	HM	523 093 772	<b>16,70 €</b>



# reťaze

PRE BENZÍNOVÉ PÍLY



			Dĺžka lišty	Delenie pílovej reťaze	Šírka drážky	Profil zubu	Objednávacie číslo	MOC EUR s DPH
	PS-5000 PS-5000 H PS-4600 S PS-4600 SH PS-4605	PS-5105/C PS-6100	33 cm/13"	0.325"	1,5 mm	VM	514 686 756	<b>11,93 €</b>
			38 cm/15"	0.325"	1,5 mm	VM	514 686 764	<b>14,82 €</b>
			45 cm/18"	0.325"	1,5 mm	VM	514 686 772	<b>16,44 €</b>
			45 cm/18"	0.325"	1,5 mm	HM	958 086 072	<b>16,48 €</b>

			Dĺžka lišty	Delenie pílovej reťaze	Šírka drážky	Profil zubu	Objednávacie číslo	MOC EUR s DPH
 	PS-7300 /HS PS-7300 H PS-7900 /HS PS-7900 H	PS-6400 /HS PS-6400 H PS-7310 PS-7910	38 cm/15"	3/8"	1,5 mm	VM	528 099 760	<b>16,83 €</b>
			43 cm/17"	3/8"	1,5 mm	VM	958 099 064	<b>17,91 €</b>
			45 cm/18"	3/8"	1,5 mm	VM	528 099 768	<b>18,37 €</b>
			50 cm/20"	3/8"	1,5 mm	VM	528 099 772	<b>17,73 €</b>
			60 cm/24"	3/8"	1,5 mm	VM	528 099 784	<b>21,66 €</b>
			70 cm/28"	3/8"	1,5 mm	VM	528 099 794	<b>23,01 €</b>

			Dĺžka lišty	Delenie pílovej reťaze	Šírka drážky	Profil zubu	Objednávacie číslo	MOC EUR s DPH
	PS-9000	PS-9010	50 cm/20"	3/8"	1,5 mm	VM	528 099 772	<b>17,73 €</b>
			60 cm/24"	3/8"	1,5 mm	VM	528 099 780	<b>19,00 €</b>
			74 cm/29"	3/8"	1,5 mm	VM	528 099 796	<b>23,41 €</b>

VM = hranatý profil zubu  
HM = guľatý profil zubu

# reťaze

MultiCut pílové reťaze



	Dĺžka lišty	Delenie pílovej reťaze	Šírka drážky	Model reťaze	Objednávacie číslo	MOC EUR s DPH
	30 cm	3/8"	1,3 mm	092	579 092 046	<b>21,99 €</b>
	35 cm	3/8"	1,3 mm	092	579 092 052	<b>16,50 €</b>
	40 cm	3/8"	1,3 mm	092	579 092 056	<b>26,08 €</b>
	38 cm	0,325"	1,3 mm	484	579 484 064	<b>21,65 €</b>
	38 cm	0,325"	1,5 mm	686	579 686 064	<b>21,41 €</b>
	45 cm	0,325"	1,5 mm	686	579 686 072	<b>36,23 €</b>
	38 cm	3/8"	1,5 mm	099	579 099 056	<b>22,76 €</b>
	43/45 cm	3/8"	1,5 mm	099	579 099 064	<b>26,17 €</b>
	45 cm	3/8"	1,5 mm	099	579 099 068	<b>30,59 €</b>
	50 cm	3/8"	1,5 mm	099	579 099 072	<b>28,76 €</b>

### *Pílové reťaze MultiCut – dlhšie ostré, aj v náročných podmienkach*

Ostrie ostáva dlhšie ostré vďaka robustnému chrómovému povlaku.

Až 3-násobne dlhšia životnosť, aj pri extrémne znečistenom dreve.

Reže materiály, na ktorých sa bežné reťaze rýchlo otupia, napr. železničné podvaly, piesčité pne stromov v koreňovej časti alebo zuhoľnatené drevo.

Na ostrenie reťaze MultiCut nie je potrebné špeciálne vybavenie. Reťaz MultiCut je možné, podobne ako bežné reťaze, ostríť pomocou okrúhleho pilníka na ostrenie reťazí.

Tým ušetríte množstvo času, pretože sa vyhnete časovo náročným návštevám špecializovaných servisov.

# reťaze

## Pílové reťaze 91VXL



	Typ reťaze	Delenie pílovej reťaze	Šírka drážky	Objednávacie číslo	MOC EUR s DPH
	91VXL/40	3/8"	1,3 mm	572 480 040	<b>16,60 €</b>
	91VXL/44	3/8"	1,3 mm	572 480 044	<b>18,17 €</b>
	91VXL/45	3/8"	1,3 mm	572 480 045	<b>18,60 €</b>
	91VXL/46	3/8"	1,3 mm	572 480 046	<b>19,01 €</b>
	91VXL/49	3/8"	1,3 mm	572 480 049	<b>16,37 €</b>
	91VXL/50	3/8"	1,3 mm	572 480 050	<b>20,67 €</b>
	91VXL/52	3/8"	1,3 mm	572 480 052	<b>21,49 €</b>
	91VXL/53	3/8"	1,3 mm	572 480 053	<b>21,59 €</b>
	91VXL/55	3/8"	1,3 mm	572 480 055	<b>22,74 €</b>
	91VXL/56	3/8"	1,3 mm	572 480 056	<b>23,05 €</b>
	91VXL/57	3/8"	1,3 mm	572 480 057	<b>23,57 €</b>

### Kedy treba pílovú reťaz naostriť?

Dobrý rezný výkon reťazovej píly je možné dosiahnuť len s ostrou pílovou reťazou, pretože ostré pílové zuby produkujú veľké piliny. Ak sa veľkosť pilín počas práce postupne znižuje, resp. dosiahne až jemnosť prášku, je to bezpečným znakom otupenej reťaze. Silnejší prítlak pri pílení nepomôže, ale zvýši len opotrebovanie spojky, lišty a reťaze.





# lišty PRE BENZÍNOVÉ PÍLY



			Dĺžka lišty	Delenie pílovej reťaze	Šírka drážky	Objednávacie číslo	MOC EUR s DPH
	PS-220 TH PS-221 TH		25 cm/10"	1/4"	1,3 mm	168395-8*	<b>50,13 €</b>
			30 cm/12"	1/4"	1,3 mm	168465-3*	<b>93,57 €</b>
			35 cm/14"	1/4"	1,3 mm	168464-5*	<b>99,17 €</b>

			Dĺžka lišty	Delenie pílovej reťaze	Šírka drážky	Objednávacie číslo	MOC EUR s DPH
	PS-32 C/TLC		30 cm/12"	3/8"	1,1 mm	958 400 001	<b>11,21 €</b>
			35 cm/14"	3/8"	1,1 mm	958 400 002	<b>12,27 €</b>
			30 cm/12"	3/8"	1,3 mm	958 500 003	<b>11,55 €</b>
			35 cm/14"	3/8"	1,3 mm	958 500 002	<b>11,88 €</b>
			40 cm/16"	3/8"	1,3 mm	958 500 051	<b>12,96 €</b>

			Dĺžka lišty	Delenie pílovej reťaze	Šírka drážky	Objednávacie číslo	MOC EUR s DPH
  	PS-32 C		30 cm/12"	3/8"	1,1 mm	412 030 211	<b>17,46 €</b>
			35 cm/14"	3/8"	1,1 mm	412 035 211	<b>15,18 €</b>
			30 cm/12"	3/8"	1,3 mm	958 400 005	<b>14,62 €</b>
			35 cm/14"	3/8"	1,3 mm	958 400 006	<b>15,08 €</b>
			40 cm/16"	3/8"	1,3 mm	958 400 007	<b>15,64 €</b>

\* záberové kolo obj. č. 320 165 405 1/4"



# lišty

## PRE BENZÍNOVÉ PÍLY

**DOLMAR**



			Dĺžka lišty	Delenie pílovej reťaze	Šírka drážky	Objednávacie číslo	MOC EUR s DPH
		PS-220 TH	25 cm/10"	3/8"	1,3 mm	168406-9	<b>9,27 €</b>
		PS-221 TH					
		PS-311 TH	30 cm/14"	3/8"	1,3 mm	MR00288413	<b>42,98 €</b>
	PS-33, PS-34, 100, 103, PS-350 C, PS-340, PS-400, PS-401, 100 s 105, PS-400, PS-401, 102, 108, PS-45	PS-35 C/TLC	30 cm/12"	3/8"	1,3 mm	958 500 003	<b>11,55 €</b>
		PS-310 TH	35 cm/14"	3/8"	1,3 mm	958 500 002	<b>11,88 €</b>
		PS-3410TH	40 cm/16"	3/8"	1,3 mm	958 500 051	<b>12,96 €</b>
		PS-350 SC					
		PS-352 / TLC					
 	PS-33, PS-34, 100, 103, PS-340, PS-350 C, PS-400, PS-401, 100 s 105, PS-400, PS-401, 102, 108, PS-45	PS-35 C	30 cm/12"	3/8"	1,3 mm	958 400 005	<b>14,62 €</b>
		PS-310 TH	35 cm/14"	3/8"	1,3 mm	958 400 006	<b>15,08 €</b>
		PS-3410TH	40 cm/16"	3/8"	1,3 mm	958 400 007	<b>15,64 €</b>
		PS-350 SC					
		PS-352					
	PS-410, PS-411, PS-420 C	PS-420 SC	33 cm/13"	0.325"	1,3 mm	414 033 141	<b>12,32 €</b>
			38 cm/15"	0.325"	1,3 mm	414 038 141	<b>15,92 €</b>
			45 cm/18"	0.325"	1,3 mm	414 045 141	<b>19,19 €</b>
		PS-3410 TH	30 cm/12"	1/4"	1,3 mm	168465-3**	<b>93,57 €</b>
			35 cm/14"	1/4"	1,3 mm	168464-5**	<b>99,17 €</b>



\*\* záberové kolo obj. č. 170 223 201 1/4"

# lišty PRE BENZÍNOVÉ PÍLY



			Dĺžka lišty	Delenie pílovej reťaze	Šírka drážky	Objednávacie číslo	MOC EUR s DPH
	109, 109HS, 111, 112, 117	PS-460 PS-500/C PS-550	38 cm/15"	3/8"	1,5 mm	958 500 001	<b>23,28 €</b>
			45 cm/18"	3/8"	1,5 mm	958 500 044	<b>25,66 €</b>

			Dĺžka lišty	Delenie pílovej reťaze	Šírka drážky	Objednávacie číslo	MOC EUR s DPH
	110, 110i, 110iH, 115i	PS-460 PS-500/C PS-550 111, 115 PS-6100	38 cm/15"	0.325"	1,5 mm	415 038 631	<b>22,11 €</b>
			40 cm/16"	0.325"	1,5 mm	415 040 631	<b>38,07 €</b>
			45 cm/18"	0.325"	1,5 mm	415 045 631	<b>24,48 €</b>

			Dĺžka lišty	Delenie pílovej reťaze	Šírka drážky	Objednávacie číslo	MOC EUR s DPH
 	110, 115i, 115iH, 116, 116 si, 120, 120 si PS-4600 S PS-5000 PS-5000 H PS-4605	115 PS-5105/C PS-6100	38 cm/15"	3/8"	1,5 mm	958 500 001	<b>23,28 €</b>
			45 cm/18"	3/8"	1,5 mm	958 500 044	<b>25,66 €</b>
			53 cm/21"	3/8"	1,5 mm	411 910 650	<b>28,60 €</b>

			Dĺžka lišty	Delenie pílovej reťaze	Šírka drážky	Objednávacie číslo	MOC EUR s DPH
	110, 115i, 115iH, 116, 116 si 120, 120 si PS-5000 PS-5000 H PS-4605	115 PS-5105/C	45 cm/18"	3/8"	1,5 mm	415 045 451*	<b>75,12 €</b>
			53 cm/21"	3/8"	1,5 mm	415 053 451*	<b>49,54 €</b>

# lišty

## PRE BENZÍNOVÉ PÍLY



			Dĺžka lišty	Delenie pílovej reťaze	Šírka drážky	Objednávacie číslo	MOC EUR s DPH
	PS-5000 PS-5000 H PS-4600 S PS-4600 SH PS-4605	PS-5105/C PS-6100	33 cm/13"	0.325"	1,5 mm	415 033 631	<b>19,89 €</b>
			38 cm/15"	0.325"	1,5 mm	415 038 631	<b>22,11 €</b>
			45 cm/18"	0.325"	1,5 mm	415 045 631	<b>24,48 €</b>

			Dĺžka lišty	Delenie pílovej reťaze	Šírka drážky	Objednávacie číslo	MOC EUR s DPH
	PS-7300 /HS PS-7300 H PS-7900 /HS PS-7900 H	PS-6400 /HS PS-6400 H PS-7310 PS-7910	38 cm/15"	3/8"	1,5 mm	415 038 655	<b>23,81 €</b>
			43 cm/17"	3/8"	1,5 mm	465 043 655	<b>23,95 €</b>
			45 cm/18"	3/8"	1,5 mm	415 045 655	<b>24,51 €</b>
			50 cm/20"	3/8"	1,5 mm	415 050 655	<b>26,61 €</b>
			60 cm/24"	3/8"	1,5 mm	415 060 555	<b>72,10 €</b>

			Dĺžka lišty	Delenie pílovej reťaze	Šírka drážky	Objednávacie číslo	MOC EUR s DPH
	PS-7300 /HS PS-7300 H PS-7900 /HS PS-7900 H	PS-6400 /HS PS-6400 H PS-7310 PS-7910	45 cm/18"	3/8"	1,5 mm	415 045 455*	<b>46,74 €</b>
			50 cm/20"	3/8"	1,5 mm	415 050 455*	<b>48,49 €</b>
			60 cm/24"	3/8"	1,5 mm	415 060 455*	<b>53,74 €</b>
			70 cm/28"	3/8"	1,5 mm	415 070 455*	<b>67,54 €</b>

# lišty

PRE BENZÍNOVÉ PÍLY

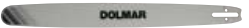

			Dĺžka lišty	Delenie pílovej reťaze	Šírka drážky	Objednávacie číslo	MOC EUR s DPH
	PS-9000	PS-9010	50 cm/20"	3/8"	1,5 mm	415 050 652	<b>36,29 €</b>
			60 cm/24"	3/8"	1,5 mm	415 060 652	<b>40,09 €</b>

			Dĺžka lišty	Delenie pílovej reťaze	Šírka drážky	Objednávacie číslo	MOC EUR s DPH
	PS-9000	PS-9010	50 cm/20"	3/8"	1,5 mm	415 050 452*	<b>59,18 €</b>
			60 cm/24"	3/8"	1,5 mm	415 060 452*	<b>61,13 €</b>
			74 cm/29"	3/8"	1,5 mm	415 074 452*	<b>58,99 €</b>

\*pancierová lišta



# Lišty PowerMatch



Profesionálne lišty Power Match

			Dĺžka lišty	Delenie pílovej reťaze	Šírka drážky	Objednávacie číslo	MOC EUR s DPH
	115, PS-4605, PS-5105, PS-6100		40	0.325"	1,5	415 040 531	<b>48,78 €</b>
	115, PS-4605, PS-5105, PS-6100		40	3/8"	1,5	415 040 551	<b>47,96 €</b>
	PS-6400, PS-7310, PS-7910		40	3/8"	1,5	415 040 555	<b>50,04 €</b>
			45	0.325"	1,5	415 045 531	<b>64,80 €</b>
			45	3/8"	1,5	415 045 551	<b>64,22 €</b>
			50	0.325"	1,5	415 050 531	<b>71,65 €</b>
			50	3/8"	1,5	415 050 551	<b>66,07 €</b>
			60	0.325"	1,5	415 060 531	<b>76,38 €</b>
		60	3/8"	1,5	415 060 551	<b>74,52 €</b>	

			Dĺžka lišty	Delenie pílovej reťaze	Šírka drážky	Objednávacie číslo	MOC EUR s DPH
			-/-	3/8"	1,5	465 000 550	<b>27,84 €</b>
			-/-	0.325"	1,5	465 000 551	<b>26,76 €</b>

# RescueCut LIŠTY A REŤAZE



## reťaze

			Dĺžka lišty	Delenie pílovej reťaze	Šírka drážky	Objednávacie číslo	MOC EUR s DPH
	PS-5000	PS-5105/C, 115	38 cm/15"	3/8"	1,5 mm	957 696 056	<b>230,90 €</b>
			45 cm/18"	3/8"	1,5 mm	957 696 064	<b>223,26 €</b>
	PS-6400, PS-7300, PS-7900	PS-7310, PS-7910	43 cm/17"	3/8"	1,5 mm	957 696 064	<b>223,26 €</b>

## pílové lišty

			Dĺžka lišty	Delenie pílovej reťaze	Šírka drážky	Objednávacie číslo	MOC EUR s DPH
	PS-5000	PS-5105/C, 115	38 cm/15"	3/8"	1,5 mm	415 038 751	<b>31,32 €</b>
			45 cm/18"	3/8"	1,5 mm	415 045 751	<b>29,51 €</b>
	PS-6400, PS-7300, PS-7900	PS-7310, PS-7910	43 cm/17"	3/8"	1,5 mm	465 043 755	<b>42,34 €</b>

## obmedzovače hĺbky

			Objednávacie číslo	MOC EUR s DPH
	PS-5000, PS-7300, PS-7900	PS-5105/C, 115, PS-6400, PS-7310, PS-7910	957 250 100	<b>147,03 €</b>



# sady RescueCut



obmedzovač hĺbky + lišta s otvorom

			Dĺžka lišty	Delenie pílovej reťaze	Šírka drážky	Objednávacie číslo	MOC EUR s DPH
	PS-5000	PS-5105/C, 115	45 cm/18"	3/8"	1,5 mm	957 415 020	<b>135,56 €</b>

obmedzovač hĺbky + lišta s otvorom + reťaz RescueCut

			Dĺžka lišty	Delenie pílovej reťaze	Šírka drážky	Objednávacie číslo	MOC EUR s DPH
 	PS-5000, PS-6400, PS-7300, PS-7900	PS-5105/C, 115	38 cm/15"	3/8"	1,5 mm	957 415 030	<b>304,80 €</b>
			45 cm/18"	3/8"	1,5 mm	957 415 040	<b>294,06 €</b>
		PS-5105/C, 115, PS-7310, PS-7910	45 cm/18"	3/8"	1,5 mm	957 415 060	<b>661,82 €</b>

# vzduchové filtre pre benzínové

	PS-32 C / TLC PS-35 C / TLC	PS-34 PS-45	PS-220 TH
	☺		
		☺	
			☺
			
			
			
			
			
			
			
			





# hobby a farmárske pily



PS-3410 TH	PS-310 TH PS-311 TH	PS-400, PS-401 PS-410, PS-411	PS-350 C/SC PS-420 C/SC	PS-352 / TLC	Objednávacie číslo	MOC EUR s DPH
					423414-0	0,87 €
					036 173 011	0,70 €
					443118-8	0,85 €
☺ plstený					170 173 021	4,95 €
	☺				MR00285584	1,88 €
		☺ nylon			028 173 041	4,34 €
		☺ Robkoflok			028 173 141	5,28 €
			☺ plstený		195 173 150	12,78 €
			☺ nylon		195 173 050	11,79 €
				☺	126370-0	8,87 €

# vzduchové filtre pre benzínové

	109 111 115	PS-460 / D / DX, PS-500 / C / D / DX PS-4600 / 4605 PS-5000 / 5105 / C	PS-6100
	☺	nylon	
	☺	Robkoflok	
			☺
			plstený
			☺
			nylon
			☺
			
			
			

# proffi píly



PS-6400, PS-7300 / 7310 PS-7900 / 7910	PS-9010	Objednávacie číslo	MOC EUR s DPH
		020 173 202	<b>11,61 €</b>
		020 173 300	<b>8,38 €</b>
		181 173 190	<b>10,58 €</b>
		181 173 090	<b>9,64 €</b>
		130 173 010	<b>9,50 €</b>
☺ plstený		038 173 101	<b>10,69 €</b>
☺ nylon		038 173 011	<b>10,23 €</b>
☺ heavy duty		957 173 400	<b>97,20 €</b>
	☺ Robkoflok	024 173 230	<b>15,59 €</b>

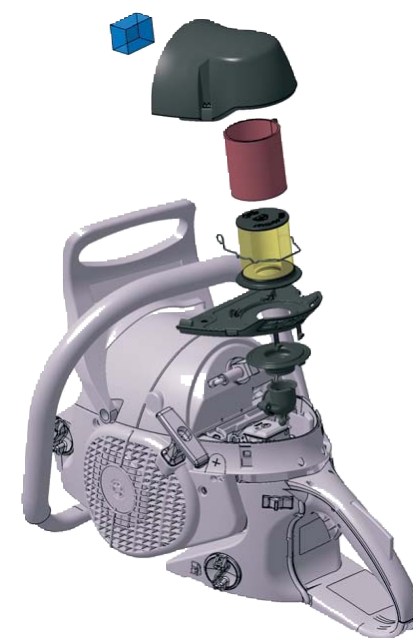

# pilníky

Okrúhly pilník

	Model reťaze	Delenie reťaze	Ø mm	Objednávacie číslo	MOC EUR s DPH
	062	1/4"	4,0	953 003 090	<b>2,02 €</b>
	290	3/8"	4,5	953 003 100	<b>1,87 €</b>
	092	3/8"	4,0	953 003 090	<b>2,02 €</b>
	084	3/8"	4,5	953 003 100	<b>1,87 €</b>
	086. 484	3/8"	4,8	953 003 070	<b>1,99 €</b>
	093	3/8"	5,5	953 003 040	<b>1,75 €</b>
	099	3/8"	5,5	953 003 040	<b>1,75 €</b>
	103	404"	5,5	953 003 040	<b>1,75 €</b>
	093. 099	3/8"	5,2	953 003 110	<b>2,00 €</b>

Plochý pilník pre obmedzovač hĺbky

	Model reťaze	Delenie reťaze	Ø mm	Objednávacie číslo	MOC EUR s DPH
	062	1/4"	–	953 003 060	<b>6,04 €</b>
	290	3/8"	–	953 003 060	<b>6,04 €</b>
	092	3/8"	–	953 003 060	<b>6,04 €</b>
	084	3/8"	–	953 003 060	<b>6,04 €</b>
	086. 484	3/8"	–	953 003 060	<b>6,04 €</b>
	093	3/8"	–	953 003 060	<b>6,04 €</b>
	099	3/8"	–	953 003 060	<b>6,04 €</b>
	103	404"	–	953 003 060	<b>6,04 €</b>
	093. 099	3/8"	–	953 003 060	<b>6,04 €</b>

# pilníky

Držiak pilníka s vodítkom

	Model reťaze	Delenie reťaze	Ø mm	Objednávacie číslo	MOC EUR s DPH
	062	1/4"	4,0	953 030 010	<b>10,35 €</b>
	290	3/8"	4,5	953 030 020	<b>13,84 €</b>
	092	3/8"	4,0	953 030 010	<b>10,35 €</b>
	084	3/25"	4,5	953 030 020	<b>13,84 €</b>
	086. 484	3/25"	4,8	953 030 030	<b>6,32 €</b>
	093	3/8"	5,5	958 500 169	<b>8,51 €</b>
	099	3/8"	5,5	958 500 169	<b>8,51 €</b>
	103	404"	5,5	958 500 169	<b>8,51 €</b>

Mierka na reťaz

	Model reťaze	Delenie reťaze	Ø mm	Objednávacie číslo	MOC EUR s DPH
	062	1/4"	–	953 100 090	<b>6,00 €</b>
	290	3/8"	–	953 100 090	<b>6,00 €</b>
	092	3/8"	–	953 100 090	<b>6,00 €</b>
	084	3/25"	–	953 100 090	<b>6,00 €</b>
	086. 484	3/25"	–	953 100 090	<b>6,00 €</b>
	093	3/8"	–	953 100 090	<b>6,00 €</b>
	099	3/8"	–	953 100 090	<b>6,00 €</b>
	103	404"	–	953 100 063	<b>2,96 €</b>
	093. 099	3/8"	–	953 100 090	<b>6,00 €</b>



# pilníky



Okrúhly pilník v blistrovom balení

	Model reťaze	Delenie reťaze	Ø mm	ks/bal	Objednávacie číslo	MOC EUR s DPH
	062	1/4"	4,0	3	958 500 162	<b>3,89 €</b>
	290	3/8"	4,5	3	958 500 163	<b>3,92 €</b>
	092	3/8"	4,0	3	958 500 162	<b>3,89 €</b>
	084	3/25"	4,5	3	958 500 163	<b>3,92 €</b>
	086. 484	3/25"	4,8	3	958 500 164	<b>3,89 €</b>
	093	3/8"	5,5	3	958 500 165	<b>3,89 €</b>
	099	3/8"	5,5	3	958 500 165	<b>3,89 €</b>
	103	404"	5,5	3	958 500 165	<b>3,89 €</b>





Rukoväte na pilníky

		Objednávacie číslo	MOC EUR s DPH
	Rukoväť na pilník drevená.	953 004 010	<b>2,01 €</b>
	Rukoväť na pilník s uhlom ostrenia.	953 008 020	<b>5,44 €</b>





# rolky reťazí

	Delenie reťaze	Šírka drážky		Počet článkov na kotúči*	Profil zuby**	Objednávacie číslo	MOC EUR s DPH
	3/8"	1,1 mm	0,043"	1637	HM	957 291 801	<b>309,90 €</b>
	3/8"	1,3 mm	0,050"	1637	HM	957 492 801	<b>279,90 €</b>
	3/8"	1,5 mm	0,058"	1637	HM	957 093 801	<b>329,90 €</b>
	3/8"	1,5 mm	0,058"	1637	VM	957 099 801	<b>339,90 €</b>
	3/8"	1,6 mm	0,063"	1637	VM	957 110 801	<b>369,90 €</b>
	0,325"	1,3 mm	0,050"	1848	HM	957 484 801	<b>319,90 €</b>
	0,325"	1,5 mm	0,058"	1848	HM	957 086 801	<b>349,90 €</b>
	0,325"	1,5 mm	0,058"	1848	VM	957 686 801	<b>359,90 €</b>





\* +/- 5 článkov na 1 kotúč  
 \*\* VM – hranatý profil zuby  
 HM – guľatý profil zuby

# brúsky



## Brúsky na ostrenie pílových reťazí

		Objednávacie číslo	MOC EUR s DPH
	Osvedčené zariadenie na ostrenie DOLMAR 340 s 230 V motorom, otáčkami 2800 min <sup>-1</sup> , 145 mm brúsnym kotúčom, na profesionálne a presné, rovnomerné ostrenie trojjazyčkových pílových reťazí DOLMAR, so vstavaným pracovným osvetlením. Súčasť dodávky: 1 brúсны kotúč 3,0 mm pre pílové reťaze 062, 084, 092 a 290. 1 brúсны kotúč 4,5 mm pre pílové reťaze 086, 093, 099 a 103. 1 brúсны kotúč 6,0 mm na brúsenie obmedzovača hĺbky. 1 obťahovací kameň a šablóna na úpravu obrysu pílového kotúča.	700 340 000	<b>835,14 €</b>
	Zariadenie na ostrenie reťazí MAXX ponúka praktické a efektívne riešenia na profesionálne ostrenie pílových reťazí. Najmä automatické zovretie pílovej reťaze vo vodiacej koľajnici pri odtlačaní brúsnej hlavy racionalizuje ostrenie reťaze. Sériovo s osvetlením brúsneho kotúča a 3 brúsnymi kotúčmi na ostrenie všetkých bežných trojjazyčkových pílových reťazí s rôznym delením. S diamantovým kotúčom, dodávaným ako príslušenstvo možno ostríť aj pílové reťaze so zubami z tvrdého kovu ako DOLMAR RescueCut.	341 013 018	<b>966,30 €</b>
	Zariadenie na ostrenie reťazí „Nick the Grinder“ je vhodné na príležitostné strojové ostrenie. Jednoduché a praktické zariadenie na rovnomerné ostrenie pílových reťazí. Ideálne ako druhé zariadenie do dielne alebo na používanie u profesionálnych zákazníkov. Sériovo s kotúčom na 3/8“ a .404“ pílové reťaze.	341 013 085	<b>422,76 €</b>











## Príslušenstvo k brúskam na ostrenie reťazí

		Objednávacie číslo	MOC EUR s DPH
	Brúсны kotúč pre zariadenie na ostrenie DOLMAR340 a MAXX pre reťaze 062, 084, 092, 290. 145 × 3 × 22 mm	965 210 026	<b>21,84 €</b>
	Brúсны kotúč pre reťaze 099, 093, 103, 086. 145 × 4,5 × 22 mm	965 210 027	<b>21,62 €</b>
	Brúсны kotúč pre zariadenie NICK. Pre reťaze 062, 084, 092, 290. 105 × 3 × 22 mm	341 013 016	<b>33,57 €</b>
	Brúсны kotúč pre reťaze 099, 093, 103, 086. 105 × 4,5 × 22 mm	341 013 015	<b>39,44 €</b>
	Diamantový kotúč pre reťaz RESCUECUT. 145 × 4 × 22 mm	341 013 014	<b>529,46 €</b>
	Brúсны kameň na brúsenie kotúčov.	965 210 001	<b>10,31 €</b>

# príslušenstvo











Príslušenstvo na opravu reťazí

		Objednávacie číslo	MOC EUR s DPH
	Prípravok na brúsenie reťazí.	953 030 040	<b>55,81 €</b>
	Zverák na upínanie lišt.	953 007 000	<b>19,89 €</b>
	Pomôcka na ostrenie pílových reťazí na lište. Pre okrúhly pilník (model reťaze), 4,0 mm (092, 062)	953 100 040	<b>21,12 €</b>
	Pomôcka na ostrenie pílových reťazí na lište. Pre okrúhly pilník (model reťaze), 4,8 mm (086, 484)	953 100 048	<b>34,73 €</b>
	Pomôcka na ostrenie pílových reťazí na lište. Pre okrúhly pilník (model reťaze), 5,5 mm (093, 099)	953 100 055	<b>34,73 €</b>
	Profesionálne zariadenie na nitovanie pílových zariadení. Umožňuje rovnomerné zalisovanie hláv nitov.	950 100 411	<b>163,08 €</b>
	Lisovací prípravok pre reťaze 1/4" a 3/8". Vhodný pre nitovacie zariadenie.	950 100 424	<b>6,20 €</b>
	Lisovací prípravok pre reťaze 3/8" a 1/2". Vhodný pre nitovacie zariadenie.	950 100 425	<b>6,21 €</b>
	Profesionálne zariadenie na roznitovanie reťazí. Ľahké vytlačanie nitov.	950 100 310	<b>189,97 €</b>
	Vyrážač pre roznitovacie zariadenie. Priemer upínacieho čapu 10 mm.	950 100 350	<b>11,75 €</b>

# príslušenstvo







## Kombinované kľúče

		Objednávacie číslo	MOC EUR s DPH
	Kombinovaný kľúč 13/16 pre hobby píly.	941 716 132	2,15 €
	Kombinovaný kľúč 13/16 pre farmárske píly.	941 713 161	2,10 €
	Kombinovaný kľúč 19/13 pre profi píly.	941 719 133	1,86 €
	Kombinovaný kľúč 17/19 pre profi píly.	941 717 192	2,20 €
	Kombinovaný kľúč 13/19 pre hobby píly.	941 719 141	1,97 €
	Kombinovaný kľúč 19/13 s 8 mm stopkou pre používanie zvieracieho prípravku na kombi kanistri.	941 719 133	1,86 €
	Kombinovaný kľúč 13 pre elektrické píly.	941 713 001	1,91 €
	Sviečkový kľúč 21 mm.	671 001 078	1,57 €
	Kľúč na vypúšťanie oleja v kosačkách/sviečkový kľúč 19/21 mm.	BR992029	3,08 €

# sviečky

## ZAPAĽOVACIE SVIEČKY

**DOLMAR**

		Typ	Objednávacie číslo	MOC EUR s DPH
	Zapaľovacia sviečka pre modely: PS-33, PS-330, PS-340/344, PS-400/401, PS-410/411	BPMR6F / NGK	958 500 041	<b>5,90 €</b>
	Zapaľovacia sviečka pre modely: PS-2, PS-3, PS-4, PS-34, PS-36, PS-41, PS-43, PS-45, PS-3400 TH, PS-3410, PS-3410 TH, PS-350 C, PS-420 C, PS-460, PS-500, PS-500 C, PS-4600 S, PS-4605, PS-5000, PS-5105, PS-5105 C, PS-52, PS-630, PS-6100, PS-6400, PS-7300, PS-7310, PS-7900, PS-7910, PS-6000i, PS-6800i, PS-9000, PS-9010, 109, 110, 111, 115, 115i, LT-30, MS-20, MS-26, MS-2600, MS-24 U, MS-30 U, MS-30 C, MS-340, MS-3310, MS-400, MS-4010, MS-4200, MS-4211, MS-4510, PC-6112, PC-6114, PC-6212, PC-6412, PC-6414, PC-7414, PC-8116, PC-8216, 309, 343, PB-500 R, PD-520 R	BPMR7A / NGK	958 500 009	<b>3,30 €</b>
	Zapaľovacia sviečka pre modely: LT-250, MS-220, MS-250, MS-252, MS-2300, MS-3200, MS-3202, PB-250, HT-2256 D, HT-2276 E	BMR7A / NGK	381 014 981	<b>2,99 €</b>
	Zapaľovacia sviečka pre modely: MS-250.4, MS-252.4 U, MS-352.4 U, MS-245.4U/UE, MS-335.4U, PS-222 TH, PS-32 C, PS-35 C, PB-7600.4	CMR6A / NGK	965 603 030	<b>6,60 €</b>
	Zapaľovacia sviečka pre modely: PS-350 SC, PS-420 SC	CMR7A-5 / NGK	965 603 040	<b>6,60 €</b>
	Zapaľovacia sviečka pre modely: MS-330U, MS-430 U, PS-352 / TLC	BPMR8Y / NGK	351 410 110	<b>6,00 €</b>
	Zapaľovacia sviečka pre všetky kosačky Dolmar s motorom Briggs & Stratton	RJ19LM / Champion	965 603 027	<b>5,30 €</b>
	Zapaľovacia sviečka pre všetky traktory Dolmar s motorom Briggs & Stratton	BS-SV	BR992301C	<b>2,90 €</b>

Zapaľovacie sviečky – servisné balenie

		ks/bal	Objednávacie číslo	MOC EUR s DPH
	WSR6F / Bosch	100	965 603 014	<b>4,90 €*</b>
	BPMR6F / NGK	100	965 603 018	<b>3,90 €*</b>
	BPMR7A / NGK	100	965 603 021	<b>3,00 €*</b>





\* cena za 1 ks



# kanistre



## Kanistre

		Objednávacie číslo	MOC EUR s DPH
	Kombinovaný kanister so stupnicou na 5 litrov paliva a 2,5 litrov oleja, červený.	949 000 030	<b>34,63 €</b>
	Kanister na 5 litrov paliva, priehľadný	949 000 033	<b>9,28 €</b>
	Kanister plastový 20 L	949 000 039	<b>42,96 €</b>







## Nalievacie hrdlá ku kanistrom

		Objednávacie číslo	MOC EUR s DPH
	Bezpečnostné nalievacie hrdlo na nalievanie oleja.	949 100 035	<b>35,23 €</b>
	Bezpečnostné nalievacie hrdlo na nalievanie paliva.	949 100 036	<b>35,23 €</b>
	Nalievacie hrdlo pre kombinované kanistre – zahnuté.	949 000 050	<b>9,07 €</b>





# kryty LIŠT A PÍLOVÝCH REŽAZÍ



		Objednávacie číslo	MOC EUR s DPH
	Kryt reťaze pre dĺžku lišty do 35 cm. 33 × 10 cm.	952 010 130	<b>2,08 €</b>
	Kryt reťaze pre dĺžku lišty do 45 cm. 43 × 10 cm.	952 010 140	<b>2,03 €</b>
	Kryt reťaze pre dĺžku lišty do 40 cm. 41 × 11 cm.	952 020 140	<b>2,54 €</b>
	Kryt reťaze pre dĺžku lišty do 50 cm. 51 × 11 cm.	952 020 150	<b>3,72 €</b>
	Kryt reťaze pre dĺžku lišty do 60 cm. 61 × 11 cm.	952 020 160	<b>3,72 €</b>
	Kryt reťaze pre dĺžku lišty do 80 cm. 81 × 13 cm.	952 030 180	<b>8,70 €</b>

## Vysávačky, dávkovače oleja

		Objednávacie číslo	MOC EUR s DPH
	Vysávačka oleja / striekačka.	664 718 000	<b>47,48 €</b>
	Dávkovač oleja – pumpa.	242072-1	<b>2,47 €</b>

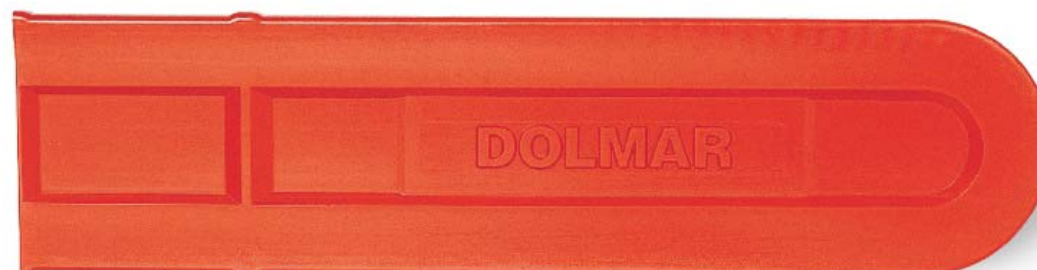

# kufre



Kovové pre benzínové a elektrické píly

		Objednávacie číslo	MOC EUR s DPH
	Kovový kufr na motorové píly. Praktický na odkladanie a transport píl. Pre benzínové píly PS-34, PS-45, 109, 111, 110, 115. Rozmer kufra: 470 × 275 × 300 mm.	988 959 034	<b>28,03 €</b>
	Kovový kufr na elektrické píly. Praktický na odkladanie a transport píl. Pre elektrické píly ES-153A, ES-163A, ES-173A, ES-183A, ES-2135A, ES-2140A. Rozmer kufra: 580 × 275 × 225 mm.	988 959 226	<b>36,56 €</b>
	Kovový kufr na elektrické píly. Praktický na odkladanie a transport píl. Pre elektrické píly ES-31A, ES-36A, ES-40A, ES-32A, ES-37A, ES-41A, ES-33A, ES-38A, ES-42A, ES-140, ES-1600, ES-30, ES-35, ES-3. Rozmer kufra: 470 × 275 × 225 mm.	988 959 200	<b>21,82 €</b>

Plastové pre benzínové a elektrické píly

		Objednávacie číslo	MOC EUR s DPH
	Plastový kufr na motorové a elektrické píly a príslušenstvo. Rozmer (68 × 34 × 24 cm). <small>* obsah kufra nie je súčasťou dodávky</small>	988 959 394	<b>31,40 €</b>



Oleje

# oleje



Olej pre dvojtakné motory 1:50

		Objednávacie číslo	MOC EUR s DPH	EUR s DPH za 1 l
	100 ml	980 008 106	<b>1,40 €</b>	<b>14,00 €</b>
	1 liter	980 008 107	<b>5,10 €</b>	<b>5,10 €</b>
	1 liter s odmerkou	980 008 112	<b>7,90 €</b>	<b>7,90 €</b>
	5 litrov	980 008 118	<b>23,00 €</b>	<b>4,60 €</b>
	60 litrov	980 008 270	<b>276,00 €</b>	<b>4,60 €</b>
	200 litrov	980 008 151	<b>822,00 €</b>	<b>4,11 €</b>

Olej EXTRA (plne syntetický) pre dvojtakné motory 1:100

		Objednávacie číslo	MOC EUR s DPH	EUR s DPH za 1 l
	1 liter	980 008 103	<b>8,90 €</b>	<b>8,90 €</b>

# oleje



Olej na mazanie pílových reťazí

		Objednávacie číslo	MOC EUR s DPH	EUR s DPH za 1 l
	1 liter	988 002 256	<b>3,60 €</b>	<b>3,60 €</b>
	5 litrov	988 002 258	<b>16,90 €</b>	<b>3,38 €</b>
	20 litrov	988 002 255	<b>63,90 €</b>	<b>3,20 €</b>
	60 litrov	988 002 265	<b>189,90 €</b>	<b>3,17 €</b>
	200 litrov	988 002 261	<b>530,00 €</b>	<b>2,65 €</b>

Olej na mazanie pílových reťazí (biologický degradovateľný)

		Objednávacie číslo	MOC EUR s DPH	EUR s DPH za 1 l
	1 liter	980 008 210	<b>4,80 €</b>	<b>4,80 €</b>
	5 litrov	980 008 211	<b>22,50 €</b>	<b>4,50 €</b>
	20 litrov	980 008 213	<b>88,00 €</b>	<b>4,40 €</b>
	60 litrov	980 008 265	<b>249,00 €</b>	<b>4,15 €</b>
	200 litrov	980 008 218	<b>799,00 €</b>	<b>4,00 €</b>

# oleje



Olej do štvortaktných kosačiek a štvortaktných krovínorezov

		Objednávacie číslo	MOC EUR s DPH	EUR s DPH za 1 l
	80 ml	196 122-3 (do vypredania zásob)	<b>2,90 €</b>	<b>36,25 €</b>
	100 ml	197 010-7	<b>4,00 €</b>	<b>40,00 €</b>
	220 ml (SAE HD 10W-30)	195615-7	<b>5,50 €</b>	<b>25,00 €</b>
	600 ml	980 008 120	<b>3,10 €</b>	<b>5,17 €</b>
	1 liter (SAE 5 W 30) * určený pre zimnú prevádzku traktorov	980 008 121	<b>6,00 €</b>	<b>6,00 €</b>

Multifunkčný olej (na čistenie a ošetrovanie)

		Objednávacie číslo	MOC EUR s DPH	EUR s DPH za 1 l
	300 ml	980 008 301	<b>5,80 €</b>	<b>19,33 €</b>

Prostriedok na čistenie pílových reťazí

		Objednávacie číslo	MOC EUR s DPH	EUR s DPH za 1 l
	500 ml	980 008 125	<b>6,60 €</b>	<b>13,20 €</b>
	5 litrov	980 008 126	<b>29,90 €</b>	<b>5,98 €</b>



# oleje



Olej na ochranu proti korózii

		Objednávacie číslo	MOC EUR s DPH	EUR s DPH za 1 l
	250 ml	980 008 302	2,00 €	8,00 €

Hydraulický olej

		Objednávacie číslo	MOC EUR s DPH	EUR s DPH za 1 l
	1 liter	988 002 500	3,90 €	3,90 €
	5 litrov	988 002 510	17,50 €	3,50 €

Vazelína na mazanie uhlových prevodov

		Objednávacie číslo	MOC EUR s DPH
	Vazelína na mazanie uhlových prevodov (50 g)	944 360 000	27,13 €



# Krovinorezy

# žacie lanká TICHÉ



	Priemer lanka	Dĺžka lanka	Objednávacie číslo	MOC EUR s DPH	EUR s DPH za 1 m
	2,0 mm	3,5 m	369 224 061	<b>1,69 €</b>	<b>0,48 €</b>
	2,0 mm	15 m	369 224 060	<b>3,09 €</b>	<b>0,21 €</b>
	2,0 mm	120 m	369 224 062	<b>14,90 €</b>	<b>0,12 €</b>
	2,4 mm	3,5 m	369 224 071	<b>1,70 €</b>	<b>0,49 €</b>
	2,4 mm	15 m	369 224 070	<b>3,60 €</b>	<b>0,24 €</b>
	2,4 mm	120 m	369 224 072	<b>17,50 €</b>	<b>0,15 €</b>

# žacie lanká TICHÉ



	Priemer lanka	Dĺžka lanka	Objednávacie číslo	MOC EUR s DPH	EUR s DPH za 1 m
	2,7 mm	15 m	369 224 673	<b>3,95 €</b>	<b>0,26 €</b>
	2,7 mm	90 m	369 224 063	<b>17,40 €</b>	<b>0,19 €</b>
	3,0 mm	15 m	369 224 674	<b>4,40 €</b>	<b>0,29 €</b>
	3,0 mm	70 m	369 224 073	<b>17,40 €</b>	<b>0,25 €</b>

špirálové lanko v tvare štvorlístku

	Priemer lanka	Dĺžka lanka	Objednávacie číslo	MOC EUR s DPH	EUR s DPH za 1 m
	2,0	15 m	197 472-9	<b>6,90 €</b>	<b>0,46 €</b>
	2,0	30 m	197 473-7	<b>13,60 €</b>	<b>0,45 €</b>
	2,0	160 m	197 474-5	<b>60,00 €</b>	<b>0,38 €</b>
	2,0	280 m	197 475-3	<b>100,00 €</b>	<b>0,36 €</b>

# žacie lanká







	Priemer lanka	Dĺžka lanka	Objednávacie číslo	MOC EUR s DPH	EUR s DPH za 1 m
 <p>Okrúhle lanko</p> <p>Okrúhle lanko</p> <p>Okrúhle lanko</p> 	1,3 mm	15 m	369 224 807	<b>1,70 €</b>	<b>0,11 €</b>
	1,6 mm	15 m	369 224 808	<b>1,85 €</b>	<b>0,12 €</b>
	2,0 mm	15 m	369 224 790	<b>1,88 €</b>	<b>0,13 €</b>
	2,0 mm	126 m	369 224 791	<b>8,25 €</b>	<b>0,07 €</b>
	2,4 mm	15 m	369 224 792	<b>2,38 €</b>	<b>0,16 €</b>
	2,4 mm	87 m	369 224 793	<b>8,86 €</b>	<b>0,10 €</b>
	2,4 mm	262 m	369 224 794	<b>23,90 €</b>	<b>0,09 €</b>
	3,0 mm	15 m	369 224 809	<b>2,99 €</b>	<b>0,20 €</b>
 <p>Okrúhle lanko +</p> 	3,0 mm	56 m	369 224 811	<b>8,89 €</b>	<b>0,16 €</b>
	3,0 mm	168 m	369 224 815	<b>23,70 €</b>	<b>0,14 €</b>
	3,3 mm	15 m	369 224 810	<b>3,35 €</b>	<b>0,22 €</b>
	3,3 mm	46 m	369 224 812	<b>8,89 €</b>	<b>0,19 €</b>
	3,3 mm	139 m	369 224 816	<b>23,70 €</b>	<b>0,17 €</b>
	3,5 mm	41 m	369 224 813	<b>8,89 €</b>	<b>0,22 €</b>
	3,5 mm	123 m	369 224 817	<b>23,70 €</b>	<b>0,19 €</b>
	4,0 mm	30 m	369 224 814	<b>8,89 €</b>	<b>0,30 €</b>
 <p>Hranaté lanko +</p> 	4,0 mm	90 m	369 224 818	<b>23,70 €</b>	<b>0,26 €</b>
	2,4 mm	15 m	369 224 795	<b>2,68 €</b>	<b>0,18 €</b>
	2,4 mm	69 m	369 224 796	<b>8,86 €</b>	<b>0,13 €</b>
	2,4 mm	206 m	369 224 797	<b>22,60 €</b>	<b>0,11 €</b>



# žacie lanká



	Priemer lanka	Dĺžka lanka	Objednávacie číslo	MOC EUR s DPH	EUR s DPH za 1 m
 <p>Hranaté lanko +</p> 	3,0 mm	15 m	369 224 819	3,67 €	0,24 €
	3,0 mm	44 m	369 224 821	8,89 €	0,20 €
	3,0 mm	132 m	369 224 825	23,70 €	0,18 €
	3,3 mm	15 m	369 224 820	3,52 €	0,23 €
	3,3 mm	36 m	369 224 822	8,89 €	0,25 €
	3,3 mm	109 m	369 224 826	23,70 €	0,22 €
	3,5 mm	32 m	369 224 823	8,89 €	0,28 €
	3,5 mm	96 m	369 224 827	23,70 €	0,25 €
	4,0 mm	25 m	369 224 824	8,89 €	0,36 €
	4,0 mm	75 m	369 224 828	23,70 €	0,32 €
 <p>Okrúhle lanko Pro</p> 	3,0 mm	15 m	369 224 798	3,49 €	0,23 €
	3,0 mm	56 m	369 224 799	10,30 €	0,18 €
	3,0 mm	168 m	369 224 800	27,00 €	0,16 €
	3,0 mm	279 m	369 224 801	39,99 €	0,14 €
 <p>Hranaté lanko Pro</p> 	3,0 mm	15 m	369 224 802	3,97 €	0,26 €
	3,0 mm	44 m	369 224 803	10,50 €	0,24 €
	3,0 mm	132 m	369 224 804	28,00 €	0,21 €
	3,0 mm	219 m	369 224 805	43,00 €	0,20 €

# žacie hlavy







		Priemer lanka	ET-40	ET-70 ET-100 C LT-27, LT-30	ET-71 C ET-101 C	ET-110 C	LT-250	LT-245,4	MS-20U	MS-22 C	MS-24 U MS-34 U	MS-26 U	MS-27 U	MS-30 C/U	CS-246,4	MS-260U	MS-330U	MS-430U
	Tap&Go	1,6 mm	☺															
	Tap&Go	1,6 mm			☺													
	Tap&Go	2,0 mm				☺												
	Tap&Go	2,0 mm		☺														
	Tap&Go	2,4 mm																
	Tap&Go	2,4 mm							☺			☺	☺					
	Tap&Go	3,0 mm																
	Tap&Go	3,0 mm																
	Tap&Go	3,0 mm																
	Tap&Go	3,0 mm																
	Tap&Go	2,7 mm							☺	☺	☺	☺			☺			
	Automatická	3,0 mm												☺		☺	☺	☺
	Automatická	2,4 mm					☺	☺					☺					
	Automatická	2,4 mm							☺	☺	☺	☺			☺			

MS-3202UE	MS-4200UE	MS-4520U	MS-245,4 U/UE MS-246,4 U/UE/CE MS-247,4 CE	MS-335,4 U	MS-5700U	MS-252,4U	MS-352,4 U/R	MS-252 U	MS-430,4 U	MS-4300,4 U	MS-340 U MS-341 U	MS-400 U	MS-3310 U	MS-4010 U MS-4011 U	MS-4510 U MS-4511 U	Objednávacie číslo	MOC EUR s DPH
																DA00000001	5,97 €
																YA00000649	7,17 €
																YA00000681	11,38 €
																680 224 200	12,16 €
									☺	☺						383 800 300 /122931-4/	28,92 €
																DA00000500	12,69 €
									☺	☺						196053-6	49,50 €
	☺					☺	☺									366 224 010	21,84 €
		☺			☺											722540/NE	7,67 €
			☺	☺												B-06507	19,30 €
											☺	☺	☺	☺	☺	384 224 503	36,75 €
																B-70518	19,57 €
☺			☺	☺				☺								381 224 263 /B-02945/	29,64 €

# žacie nože







pre krovinorezy

		MS-20 U	MS-24 U MS-34 U	MS-26 U	MS-27 U	CS-246.4	MS-260 U	MS-330 U	MS-430U	MS-3202 UE	MS-4200 UE
	8 zubový vyžinací nôž 255 × 20										
	8 zubový vyžinací nôž 230 × 25,4	☺		☺	☺						☺
	8 zubový vyžinací nôž 255 × 25,4										
	4 zubový žací nôž 230 × 25,4	☺	☺	☺	☺	☺	☺	☺	☺		☺
	4 zubový žací nôž 255 × 25,4										
	4 zubový žací nôž 255 × 25,4									☺	☺
	4 zubový žací nôž 255 × 20										
	Nôž na burinu 255 × 20										
	Nôž na burinu 255 × 25,4			☺	☺						
	Nôž na burinu 300 × 20										
	Nôž na burinu 300 × 25,4										
	Nôž na burinu 300 × 25,4										
	Pílový kotúč na krovie 200 × 20										
	Pílový kotúč na krovie 225 × 20										

MS-4520U	MS-245,4 MS-246,4 U/UE/CE	MS-335,4 U/K	MS-5700U	MS-252,4U	MS-352,4 U/R	MS-252 U	MS-340 U MS-341 U	MS-400 U	MS-3310 U	MS-4010 U MS-4011 U	MS-4510 U MS-4511 U	MS-430.4 U MS-4300.4 U/R	Objednávacie číslo	MOC EUR s DPH
							☺	☺	☺	☺	☺		385 224 180	<b>8,84 €</b>
	☺	☺				☺						☺	362 224 180	<b>12,14 €</b>
☺			☺										600 040	<b>7,14 €</b>
	☺	☺		☺		☺						☺	362 224 140	<b>11,58 €</b>
☺			☺										600 050	<b>7,13 €</b>
		☺			☺								363 224 140	<b>7,40 €</b>
							☺	☺	☺	☺	☺		385 224 140	<b>8,91 €</b>
							☺						385 224 350	<b>17,01 €</b>
	☺	☺			☺	☺						☺	385 224 340	<b>15,67 €</b>
									☺	☺	☺		385 224 130	<b>8,97 €</b>
		☺			☺							☺	385 224 150	<b>18,45 €</b>
									☺	☺	☺		385 224 171	<b>24,62 €</b>
										☺	☺	☺	385 224 161	<b>22,63 €</b>

# kryty žacích hláv a nožov







		ET-40	ET-70/100C	ET-71 C ET-101 C	ET-110 C	LT-250	LT-245,4	MS-20 U	MS-22 C	MS-24 U	MS-26 U	MS-34 U	CS-246.4	MS-260U	MS-330U	MS-430U	MS-3202UE
	kryt komplet											☺					
	kryt žacej hlavy			☺													
	kryt žacej hlavy				☺												
	kryt komplet	☺															
	kryt komplet		☺														
	kryt komplet					☺											
	kryt komplet						☺										
	kryt komplet								☺								
	kryt komplet									☺							
	kryt komplet										☺						
	kryt noža										☺						
	násuvný kryt žacej hlavy										☺						☺
	kryt noža													☺	☺	☺	
	násuvný kryt žacej hlavy													☺	☺	☺	
	kryt komplet																☺
	kryt noža																☺
	kryt komplet																
	kryt noža																
	kryt noža																
	kryt noža																
	násuvný kryt žacej hlavy																
	kryt noža																
	kryt noža												☺				
	násuvný kryt žacej hlavy												☺				
	kryt noža																
	kryt komplet																
	kryt komplet																
	kryt noža																
	kryt komplet																
	kryt komplet																
	kryt pilového kotúča Ø 200 mm																
	kryt pilového kotúča Ø 225 mm																

MS-4200UE	MS-4520U	MS-245.4 U/UE	MS-245.4 CE MS-247.4 CE	MS-246.4 U/UE	MS-335.4 U	MS-5700U	MS-252.4U	MS-352.4 U/R	MS-252 U	MS-340 U MS-400 U MS-341 U	MS-3310U, MS-4010 U MS-4510 U, MS-4011 U MS-4511 U	MS-430.4 U MS-4300.4 U	Objednávacie číslo	MOC EUR s DPH
													140 424-9	7,07 €
													YA00000653	4,80 €
													YA00000636	4,41 €
													DA00000047	3,64 €
													680 171 000	6,36 €
													388 800 600	19,35 €
													453 782-7	4,37 €
													619 801 4001	15,47 €
													DA00000526	4,40 €
													619 801 4001	15,47 €
													625 806 4001	16,70 €
													625 806 5001	9,76 €
☺													140 424-9	7,07 €
													351 504 101	49,31 €
													351 504 102	24,47 €
													367 801 100	29,70 €
													367 801 200	15,55 €
☺													635 800 8004	14,32 €
☺													381 800 700	23,44 €
	☺					☺							542410/NE	7,62 €
	☺					☺							729200	3,81 €
		☺	☺										452260-4	5,87 €
				☺									367 452 260	7,58 €
		☺	☺	☺	☺							☺	135 753-3	4,29 €
					☺							☺	452 259-9	6,04 €
							☺						365 725 260	10,98 €
								☺					XNR0000343	7,62 €
									☺				625 806 0002	14,60 €
									☺				625 806 1002	8,27 €
										☺			010 341 202	22,49 €
											☺		010 341 612	42,86 €
											☺		010 341 030	24,38 €
											☺		010 341 100	66,29 €



# popruhy



		MS-20 U	MS-24 U	MS-26 U	MS-34 U	MS-260 U	MS-330 U	MS-430 U	MS-3202 UE	MS-4200 UE	MS-4520 U	MS-5700 U
	Jednoramenný popruh.											
	Jednoramenný popruh.	☺	☺	☺		☺	☺	☺				
	Dvojranný popruh.				☺				☺	☺		
	Dvojranný popruh.										☺	☺
	Dvojranný popruh.								☺	☺		
	Dvojranný popruh – PROFI.								☺	☺		
	Dvojranný popruh – PROFI.											

MS-245.4 CE MS-247.4 CE	MS-245.4 U/UE	MS-246.4 U/UE	MS-335.4 U	MS-252.4 U	MS-352.4 U	MS-252 U	MS-340 U MS-341 U	MS-400 U	MS-3310 U	MS-4010 U	MS-4510 U MS-4011 U MS-4511 U	MS-430.4 U MS-4300.4 U	Objednávacie číslo	MOC EUR s DPH
☺													125516-5	2,46 €
													351 509 010	14,32 €
	☺		☺	☺	☺								988 048 327	22,14 €
													C19994	18,36 €
						☺	☺	☺	☺	☺	☺		988 048 324	46,89 €
		☺				☺	☺	☺	☺	☺	☺		122907-1	17,01 €
												☺	196335-6	40,77 €

# žacie hlavy



		Vhodné pre modely	Objednávacie číslo	MOC EUR s DPH
	žacia hlava	MS-260 U, MS-330 U, MS-430 U	B-06507 /351 502 030/	<b>19,30 €</b>
	kryt hlavy spodný	MS-260 U, MS-330 U, MS-430 U	351 502 032	<b>13,49 €</b>
	bubon silónu	MS-260 U, MS-330 U, MS-430 U	351 502 033	<b>12,28 €</b>
	kryt hlavy – domec	MS-260 U, MS-330 U, MS-430 U	351 502 031	<b>11,57 €</b>
	pružina	MS-260 U, MS-330 U, MS-430 U	351 502 037	<b>3,58 €</b>
	adaptér	MS-260 U, MS-330 U, MS-430 U	351 502 034	<b>6,62 €</b>
	očko nylónovej hlavy	MS-260 U, MS-330 U, MS-430 U	351 502 015	<b>2,19 €</b>



		Vhodné pre modely	Objednávacie číslo	MOC EUR s DPH
	žacia hlava	MS-20U, MS-26U, MS-245.4U,UE, MS-335.4U, MS-252U, LT-245.4, MS-3202, MS-246.4 U/UE, MS-24U, CS-246.4 C/CBC, MS-247.4 CE	381 224 263 /B-02945/	<b>29,64 €</b>
	veko hlavy	MS-20U, MS-26U, MS-245.4U,UE, MS-335.4U, MS-252U, LT-245.4, MS-3202, MS-246.4 U/UE, MS-24U, CS-246.4 C/CBC, MS-247.4 CE	B-70390	<b>3,67 €</b>
	vnútorné telo hlavy	MS-20U, MS-26U, MS-245.4U,UE, MS-335.4U, MS-252U, LT-245.4, MS-3202, MS-246.4 U/UE, MS-24U, CS-246.4 C/CBC, MS-247.4 CE	A-15986	<b>1,82 €</b>
	bubon silónu	MS-20U, MS-26U, MS-245.4U,UE, MS-335.4U, MS-252U, LT-245.4, MS-3202, MS-246.4 U/UE, MS-24U, CS-246.4 C/CBC, MS-247.4 CE	A-15970	<b>2,72 €</b>
	adaptér M8 (LH)	MS-20U, MS-26U, MS-245.4U,UE, MS-335.4U, MS-252U, LT-245.4, MS-3202, MS-246.4 U/UE, MS-24U, CS-246.4 C/CBC, MS-247.4 CE	A-16025	<b>2,73 €</b>
	očko nylónovej hlavy	MS-20U, MS-26U, MS-245.4U,UE, MS-335.4U, MS-252U, LT-245.4, MS-3202, MS-246.4 U/UE, MS-24U, CS-246.4 C/CBC, MS-247.4 CE	A-15992	<b>2,70 €</b>
	kryt hlavy – domec	MS-20U, MS-26U, MS-245.4U,UE, MS-335.4U, MS-252U, LT-245.4, MS-3202, MS-246.4 U/UE, MS-24U, CS-246.4 C/CBC, MS-247.4 CE	A-16003	<b>13,72 €</b>
	pružina	MS-20U, MS-26U, MS-245.4U,UE, MS-335.4U, MS-252U, LT-245.4, MS-3202, MS-246.4 U/UE, MS-24U, CS-246.4 C/CBC, MS-247.4 CE	A-16097	<b>2,95 €</b>
	montážny kľúč	MS-20U, MS-26U, MS-245.4U,UE, MS-335.4U, MS-252U, LT-245.4, MS-3202, MS-246.4 U/UE, MS-24U, CS-246.4 C/CBC, MS-247.4 CE	A-16069	<b>2,61 €</b>







# žacie hlavy



		Vhodné pre modely	Objednávacie číslo	MOC EUR s DPH
	žacia hlava	MS-30C,U, MS-340 U, MS-400 U, MS-3310 U, MS-4010 U, MS-4011 U, MS-4510 U, MS-4511 U	384 224 503	<b>36,75 €</b>
	kryt hlavy spodný	MS-30C,U, MS-340 U, MS-400 U, MS-3310 U, MS-4010 U, MS-4011 U, MS-4510 U, MS-4511 U	384 224 520	<b>9,99 €</b>
	krytka nyl. hlavy spodná	MS-30C,U, MS-340 U, MS-400 U, MS-3310 U, MS-4010 U, MS-4011 U, MS-4510 U, MS-4511 U	384 224 530	<b>8,63 €</b>
	bubon silónu	MS-30C,U, MS-340 U, MS-400 U, MS-3310 U, MS-4010 U, MS-4011 U, MS-4510 U, MS-4511 U	385 224 571	<b>9,17 €</b>
	pružina	MS-30C,U, MS-340 U, MS-400 U, MS-3310 U, MS-4010 U, MS-4011 U, MS-4510 U, MS-4511 U	384 224 510	<b>2,02 €</b>
	adaptér (M10 × 1,25 L)	MS-30C,U, MS-340 U, MS-400 U, MS-3310 U, MS-4010 U, MS-4011 U, MS-4510 U, MS-4511 U	387 224 590	<b>4,59 €</b>
	adaptér (M12 × 1,5 L)	MS-30C,U, MS-340 U, MS-400 U, MS-3310 U, MS-4010 U, MS-4011 U, MS-4510 U, MS-4511 U	385 224 550	<b>3,88 €</b>
	skrutka hlavy horná	MS-30C,U, MS-340 U, MS-400 U, MS-3310 U, MS-4010 U, MS-4011 U, MS-4510 U, MS-4511 U	384 224 540	<b>5,31 €</b>
	očko nylónovej hlavy	MS-30C,U, MS-340 U, MS-400 U, MS-3310 U, MS-4010 U, MS-4011 U, MS-4510 U, MS-4511 U	385 224 560	<b>2,71 €</b>







# žacie hlavy



		Vhodné pre modely	Objednávacie číslo	MOC EUR s DPH
	žacia hlava	MS-430.4 U, MS-4300.4 U	196053-6	<b>49,50 €</b>
	kryt hlavy vrchný	MS-430.4 U, MS-4300.4 U	453957-8	<b>6,15 €</b>
	kryt hlavy spodný	MS-430.4 U, MS-4300.4 U	453960-9	<b>6,29 €</b>
	Tap & Go tlačítko	MS-430.4 U, MS-4300.4 U	453961-7	<b>2,94 €</b>
	bubon silónu	MS-430.4 U, MS-4300.4 U	453958-6	<b>4,22 €</b>
	prevodová doska	MS-430.4 U, MS-4300.4 U	453956-0	<b>5,11 €</b>
	pružina	MS-430.4 U, MS-4300.4 U	234260-4	<b>3,39 €</b>
	pružina	MS-430.4 U, MS-4300.4 U	234259-9	<b>5,21 €</b>
	skrutka hlavy M10	MS-430.4 U, MS-4300.4 U	318918-4	<b>3,88 €</b>
	očko nylónovej hlavy	MS-430.4 U, MS-4300.4 U	318917-6	<b>2,31 €</b>
	platnička	MS-430.4 U, MS-4300.4 U	453955-2	<b>3,86 €</b>

# žacie hlavy



		Vhodné pre modely	Objednávacie číslo	MOC EUR s DPH
	žacia hlava	LT-27, MS-20 U, MS-26 U, MS-252 U, MS-27 U	DA00000500	<b>12,69 €</b>
	kryt hlavy spodný	LT-27, MS-20 U, MS-26 U, MS-252 U, MS-27 U	DA00000168	<b>2,68 €</b>
	bubon silónu	LT-27, MS-20 U, MS-26 U, MS-252 U, MS-27 U	DA00000166	<b>2,97 €</b>
	kryt hlavy – domec	LT-27, MS-20 U, MS-26 U, MS-252 U, MS-27 U	DA00000440	<b>4,29 €</b>
	pružina	LT-27, MS-20 U, MS-26 U, MS-252 U, MS-27 U	DA00000165	<b>0,77 €</b>
	podložka spodná	LT-27, MS-20 U, MS-26 U, MS-252 U, MS-27 U	DA00000164	<b>0,36 €</b>
	podložka vrchná	LT-27, MS-20 U, MS-26 U, MS-252 U, MS-27 U	DA00000164	<b>0,36 €</b>



# krovinorez



		Objednávacie číslo	MOC EUR s DPH
	Kryt noža Ø 285 mm	385 341 300	<b>163,86 €</b>
	Kryt noža Ø 430 mm	385 341 301	<b>167,77 €</b>
	Žací nôž Ø 255 × 20mm MS-341 U, MS-3310 U, MS-4010 U, MS-4011 U, MS-4510 U, MS-4511 U	385 224 300	<b>65,90 €</b>
	Žací nôž Ø 255 × 25,4 mm MS-335.4 U, MS-430.4 U, MS-4300.4 U	385 224 301	<b>55,92 €</b>

# krovinorez

MS-26 C, MS-245,4 CE











		Objednávacie číslo	MOC EUR s DPH
	Kultivátor.  Zobrazená hriadeľ nie je súčasťou tohto nadstavca.	B-04818	153,26 €





# Štvortaktný multifunkčný krovínorez CS-246.4 C/BC



		Objednávacie číslo	MOC EUR s DPH
	Nadstavec kultivátor MS-CS	195717-9	<b>174,64 €</b>
	Nôž pre kultivátor MS-CS	360 020 200	<b>44,47 €</b>
	Nadstavec na kosenie trávy BC-CS	195663-6	<b>83,70 €</b>
	Žacia hlava pre BC-SC	381 224 240	<b>16,28 €</b>
	Nadstavec na kosenie trávy zahnutý LT-CS	195566-4	<b>72,34 €</b>
	Nadstavec na opilovanie konárov PS-CS	196105-3	<b>219,28 €</b>
	Lišta 25cm/10" pre PS-CS	360 308 940	<b>63,91 €</b>
	Reťaz 25cm/10" 3/8" pre PS-CS	511 290 739	<b>11,45 €</b>
	Nadstavec na živé ploty HT-CS	196346-1	<b>255,33 €</b>
	Strihací nôž pre HT-CS	224143009A	<b>49,29 €</b>
	Predĺženie 1 m SE-CS	196035-8	<b>111,95 €</b>
	Taška	195639-3	<b>27,14 €</b>

# príslušenstvo



		Objednávacie číslo	MOC EUR s DPH
	Ochrana proti zamotaniu lanka pri intenzívnom kosení a na stabilizáciu žacej hlavy na krovinoresoch MS-3310, MS-4010 a MS-4510.	385 224 521	7,18 €
	Žacie držadlo na optimálne a neunavujúce držanie tela pri intenzívnom kosení. Pre krovinoresy MS-340, MS-3310, MS-4010 a MS-4510. Zobrazená hriadeľ nie je súčasťou tohto nadstavca.	385 310 401	72,24 €

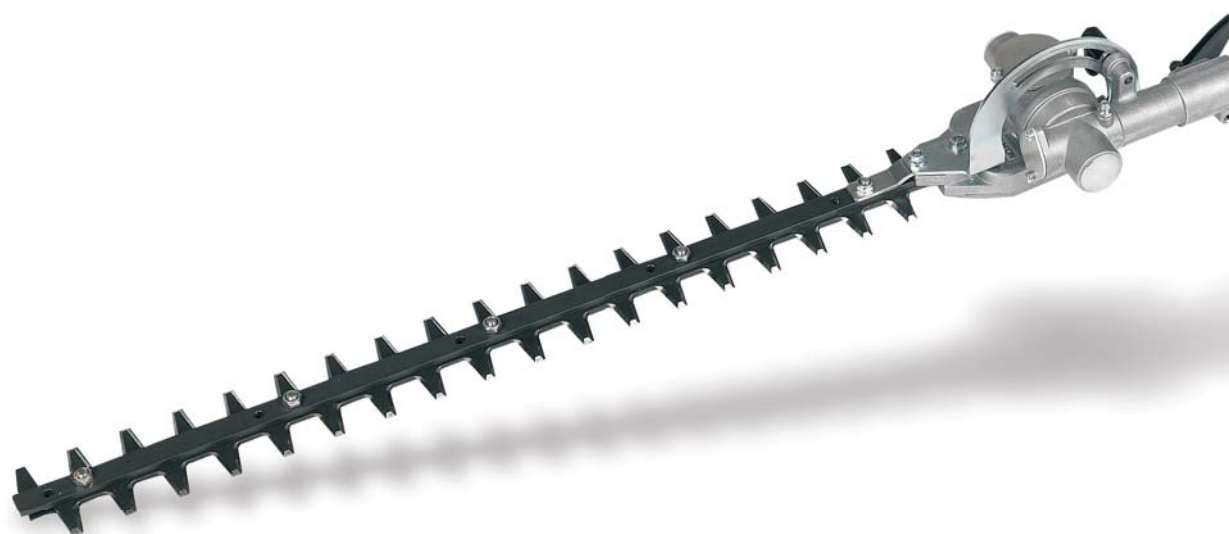









Kosačky





# žacie nože

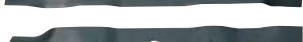
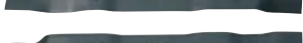
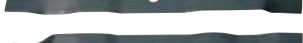

pre elektrické kosačky

	EM-3310	EM-3511	EM-33	EM-3713	EM-3913	EM-37	EM-330	EM-370	EM-380
						☺		☺	
			☺				☺		
	☺	☺							
				☺	☺				
									
									
									
									☺
									

unášače pre elektrické kosačky

	EM-3310 EM-3511	EM-33	EM-3713 EM-3913	EM-37 EM-330 EM-370
	☺		☺	
		☺		☺
	☺		☺	
		☺		☺

EM-41	EM-4316	EM-460 EM-460 S	EM-461 / S	EM-4818 EM-4818 S	Objednávacie číslo	MOC EUR s DPH
					671 002 549	<b>8,86 €</b>
					671 002 550	<b>8,02 €</b>
					664 004 115	<b>15,63 €</b>
					664 004 117	<b>18,02 €</b>
	☺				664 531 043	<b>9,69 €</b>
				☺	664 531 048	<b>12,25 €</b>
			☺		671 146 102	<b>15,04 €</b>
☺					671 001 427	<b>11,14 €</b>
					DA00000916	<b>5,90 €</b>
		☺			671 146 102	<b>15,04 €</b>









EM-380	EM-41	EM-4316	EM-460 / S	EM-461 / S	EM-4818 / S	Objednávacie číslo	MOC EUR s DPH
☺						DA00000917	<b>1,30 €</b>
						664 465 602	<b>6,36 €</b>
		☺			☺	664 998 186	<b>11,21 €</b>
						671 492 001	<b>9,81 €</b>
	☺					671 325 001	<b>6,31 €</b>
				☺		671 005 057	<b>10,15 €</b>
			☺			671 478 001	<b>9,68 €</b>
						664 004 352	<b>4,45 €</b>
		☺			☺	664 793 101	<b>0,97 €</b>
				☺		671 100 802	<b>0,37 €</b>
☺						671 006 017	<b>0,51 €</b>
	☺		☺			671 001 008	<b>3,06 €</b>





# žacie nože



pre benzínové kosačky

	PM-410 PM-411 / C	PM-42 PM-43	PM-46 /N/S/C	PM-460 PM-461 / R	PM-462 / C PM-46 SBC PM-460 S	PM-4600 S / S3 PM-4601 S / SC / S3C PM-4602 SC / S3C / R	PM-4660 S1 PM-4655 S4	PM-48 / S
		☺						
								☺
							☺	
	☺							
			☺	☺	☺	☺		
								
								

unášače pre benzínové kosačky

	PM-410	PM-42 PM-43	PM-46 /N/S/SBC	PM-460 PM-462 / C	PM-4602 S PM-5102 S3 / S3C	PM-461	PM-4600 S / S3	PM-4601 S / SC / S3C PM-4602 SC / S3C	PM-4602 SR PM-5600S3R	PM-4660S1	PM-4655 S4	PM-48	PM-48 S	PM-480	PM-480 S4	
				☺	☺	☺	☺	☺	☺							
	☺															
		☺										☺			☺	
				☺							☺			☺		☺
		☺														
						☺		☺			☺	☺	☺	☺	☺	
	☺		☺	☺	☺		☺		☺							



PM-480 / S4	PM-4810 PM-4820 / S	PM-530 / S	PM-5120 / S / R	PM-5100 S3 PM-5101 S3 / S3C / R PM-5102 S3 / S3C	PM-5600 S3 PM-5600 S3C / R	PM-5175 S1 PM-5165 S3	PM-4860 / S / S4	PM-5360 S3 / S3E	PM-5365 S3 pro	Objednávacie číslo	MOC EUR s DPH
										664 531 043	9,69 €
☺										664 531 048	12,25 €
		☺				☺		☺	☺	664 004 381	12,41 €
							☺			664 004 366	9,33 €
			☺							DA00000944	10,69 €
										671 001 433	12,25 €
										671 014 610	15,04 €
				☺						671 002 552	17,19 €
					☺					671 002 532	18,51 €
	☺									671 003 181	12,53 €

PM-530	PM-4810 PM-4820 / S	PM-530 S	PM-5120	PM-5120 S	PM-5100 S3	PM-5101 S3 / S3C PM-5600 S3	PM-5175 S1	PM-5165 S3	PM-5600 S3C	PM-4860	PM-4860 S / S4	PM-5360 S3 / S3E	PM-5365 S3 pro	Objednávacie číslo	MOC EUR s DPH
														DA00000857	5,22 €
					☺	☺			☺					671 002 977	6,46 €
☺										☺				664 463 012	13,31 €
		☺					☺				☺	☺	☺	664 465 607	17,97 €
			☺											671 002 051	10,28 €
				☺										671 002 049	12,81 €
														671 002 448	6,46 €
	☺													671 208 602	9,93 €
								☺						664 465 608	15,94 €
☺		☺					☺	☺		☺	☺	☺	☺	664 735 698	2,27 €
					☺									671 006 065	1,05 €
				☺										671 006 141	2,07 €
	☺		☺			☺			☺					DA00000528	0,86 €

# mulčovacie klíny



pre elektrické kosačky

	EM-460	EM-460 S	EM-461 / S	EM-4818	EM-4818 S
				☺	☺
	☺	☺			
			☺		

Objednávacie číslo	MOC EUR s DPH
664 140 223	<b>9,96 €</b>
671 469 001	<b>11,32 €</b>
671 936 001	<b>12,95 €</b>



# mulčovacie klíny



pre benzínové kosačky







	PM-410 PM-411	PM-46 SBC	PM-460 PM-4600 S / 3	PM-462 / C PM-4602 S / SC / S3C / R PM-5102 S3 / S3C	PM-461 PM-46 N,S PM-4601 S / SC / S3 / S3C	PM-48 / S	PM-480 / S4	PM-530 / S	PM-4860 / S	PM-4860 S4
						☺	☺			
								☺		
	☺	☺								
			☺							
					☺					
				☺						
									☺	☺

PM-4860 S4E	PM-4660 S1	PM-4655 S4	PM-5165 S3	PM-5175 S1	PM-5100 S3 PM-5101 S3 / S3C	PM-5360 S3	PM-5360 S3E	PM-5365 S3 pro	PM-5600 S3 / S3C / R	Objednávacie číslo	MOC EUR s DPH
										664 140 223	9,96 €
										664 140 222	25,97 €
										671 326 001	10,67 €
										671 450 001	11,02 €
										671 469 001	11,32 €
					☺					671 509 001	10,29 €
										671 660 001	8,27 €
										671 936 001	12,95 €
☺	☺	☺	☺	☺		☺	☺	☺		664 140 224	23,71 €
									☺	671 315 001	20,78 €



# elektrické vertikutátory

nože pre prevzdušňovače trávnikov a kultivátory



		Objednávacie číslo	MOC EUR s DPH
	Nôž pre EV-3918  • vertikutátor EV-3918 má 15 nožov	682 018 430	<b>14,99 €</b>
	Valec nože pre EV-3213	652 024 718	<b>25,48 €</b>
	Valec struny pre EV-3213	652 024 719	<b>33,72 €</b>
	Valec nože pre EV-3618	652 024 746	<b>22,69 €</b>
	Valec struny pre EV-3618	652 024 750	<b>19,59 €</b>
	Valec kombi 2 v 1 pre EV-3618	652 024 749	<b>59,94 €</b>



# benzínové vertikutátory/kultivátory



nože pre prevzdušňovače trávnikov a kultivátory

		Objednávacie číslo	MOC EUR s DPH
	Nôž pre PV-3936 <ul style="list-style-type: none"><li>• vertikutátor PV-3936 má 15 nožov</li></ul>	682 018 430	<b>14,99 €</b>
	Nôž pre PV-4245 Pro <ul style="list-style-type: none"><li>• vertikutátor PV-4245 Pro má 20 nožov</li></ul>	669 024 370	<b>10,09 €</b>











# Traktory

# mulčovacie klíny



pre traktory

	RM-63,7	RM-72,13 H	TM92,14	TM92,14 H	TM-102,16	TM-102,18 H	TM-98,14 H2D	TM-102,20 H2	TM-122,22 H2
	☺								
		☺							
			☺	☺					
					☺	☺		☺	
									☺
							☺		









Objednávacie číslo	MOC EUR s DPH
664 900 042	<b>83,18 €</b>
664 900 036	<b>54,03 €</b>
664 900 038	<b>126,73 €</b>
664 900 045	<b>59,44 €</b>
664 900 046	<b>134,22 €</b>
664 900 040	<b>64,32 €</b>



# žacie nože



pre traktory

	RM-63,7	RM-72,13 H	TM92,14	TM92,14 H	TM-102,16	TM-102,18 H	TM-98,14 H2D	TM-102,20 H2	TM-122,22 H2
	☺								
		☺							
			☺	☺					
			☺	☺					
					☺	☺		☺	
					☺	☺		☺	
							☺		
									☺
									☺







Objednávacie číslo	MOC EUR s DPH
664 109 504	<b>38,55 €</b>
664 109 503	<b>55,52 €</b>
664 004 344 <sup>ľavý</sup>	<b>21,50 €</b>
664 004 345 <sup>pravý</sup>	<b>22,16 €</b>
664 004 340 <sup>ľavý</sup>	<b>27,67 €</b>
664 004 341 <sup>pravý</sup>	<b>27,67 €</b>
664 004 346	<b>14,23 €</b>
664 004 342 <sup>ľavý</sup>	<b>40,64 €</b>
664 004 343 <sup>pravý</sup>	<b>40,44 €</b>







# mulčovacie nože



pre traktory

	TM92,14	TM92,14 H	TM-102,16	TM-102,18 H	TM-98,14 H2D	TM-102,20 H2	TM-122,22 H2
					☺		
			☺	☺		☺	
			☺	☺		☺	
							☺
							☺
	☺	☺					
	☺	☺					

sady /nože a klíny/ pre traktory

	RM-72,13 H	TM92,14	TM92,14 H	TM-102,16	TM-102,18 H	TM-102,20 H2	TM-122,22 H2
	☺						
		☺	☺				
				☺	☺	☺	
							☺









Objednávacie číslo	MOC EUR s DPH
664 004 346	<b>14,23 €</b>
664 004 347	<b>27,73 €</b>
664 004 348	<b>27,44 €</b>
664 004 350	<b>44,09 €</b>
664 004 349	<b>44,66 €</b>
664 004 354	<b>21,86 €</b>
664 004 353	<b>21,86 €</b>

Objednávacie číslo	MOC EUR s DPH
664 900 136	<b>80,01 €</b>
664 900 138	<b>80,01 €</b>
664 900 145	<b>85,99 €</b>
664 900 146	<b>80,94 €</b>





# traktory

		RM-63,7	RM-72,13 H	TM92,14	TM92,14 H
	Príves TK-250 za traktor, nosnosť do 250 kg, vyberateľná zadná stena, pozinkovaný, 1050 × 750 × 305 cm.			☺	☺
	Ťažné zariadenie pre príves TK-250 pre modely TM-92, TM-102 a TM-122.			☺	☺
	Ťažné zariadenie pre príves TK-250.				
	Zariadenie na zber trávy, objem cca 700 l, rám z pozinkovaných rúr, plachta odolná voči poveternostným vplyvom, vysokoflexibilná zberná hadica.				
	Snehové reťaze pre modely TM-92-122.  Reťaze sú dodávané samostatne bez zobrazeného disku a pneumatiky.			☺	☺
	Snehové reťaze pre modely TM-102-122.  Reťaze sú dodávané samostatne bez zobrazeného disku a pneumatiky.				

TM-98,14 H2D	TM-102,16	TM-102,18 H	TM-102,20 H2	TM-122,22 H2	Objednávacie číslo	MOC EUR s DPH
☺	☺	☺	☺	☺	663 110 804	<b>333,84 €</b>
	☺	☺	☺	☺	663 111 300	<b>70,68 €</b>
☺					664 900 085	<b>28,34 €</b>
	☺	☺	☺	☺	663 111 120	<b>482,57 €</b>
☺	☺	☺	☺	☺	663 111 140	<b>120,01 €</b>
	☺	☺	☺	☺	663 110 948	<b>270,95 €</b>



# príslušenstvo pre traktory

		RM-63,7	RM-72,13 H	TM92,14	TM92,14 H
	Deflektor.		☺		
	Deflektor.			☺	☺
	Deflektor.				
	Montážny rám.			☺	☺
	Montážny rám.				

TM-98,14 H2D	TM-102,16	TM-102,18 H	TM-102,20 H2	TM-122,22 H2	Objednávacie číslo	MOC EUR s DPH
					664 900 090	<b>63,63 €</b>
					664 900 051	<b>123,04 €</b>
	☺	☺	☺	☺	664 900 015	<b>54,22 €</b>
☺					663 111 010	<b>234,79 €</b>
	☺	☺	☺	☺	663 111 014	<b>223,76 €</b>

# príslušenstvo pre traktory

		RM-63,7	RM-72,13 H	TM92,14	TM92,14 H
	Rýchlomenič bez pohonu.		☺	☺	☺
	Rýchlomenič s pohonom.		☺	☺	☺
	Pohonová sada.			☺	☺
	Pohonová sada.				

TM-98,14 H2D	TM-102,16	TM-102,18 H	TM-102,20 H2	TM-122,22 H2	Objednávacie číslo	MOC EUR s DPH
😊	😊	😊	😊	😊	663 110 810	<b>58,75 €</b>
😊	😊	😊	😊	😊	663 110 809	<b>200,24 €</b>
					663 111 016	<b>121,52 €</b>
	😊				663 111 019	<b>151,84 €</b>

# príslušenstvo pre traktory

		RM-63,7	RM-72,13 H	TM92,14	TM92,14 H
	Pohonová sada.				
	Zametač TK-520.			☺	☺
	Radlica TS-125.			☺	☺
	Plachta na traktor.		☺	☺	☺
	Nakladacia rampa, nosnosť 500 kg/pár, dĺžka 200 cm, šírka 26 cm. Hmotnosť jednej lyžiny 14,5 kg.	☺	☺	☺	☺
	Predné závažie.		☺	☺	☺











TM-98,14 H2D	TM-102,16	TM-102,18 H	TM-102,20 H2	TM-122,22 H2	Objednávacie číslo	MOC EUR s DPH
		☺	☺	☺	663 111 020	<b>117,83 €</b>
☺	☺	☺	☺	☺	663 110 805	<b>2 172,59 €</b>
☺	☺	☺	☺	☺	663 110 808	<b>765,72 €</b>
☺	☺	☺	☺	☺	664 900 105	<b>56,17 €</b>
☺	☺	☺	☺	☺	313 000 001	<b>299,00 €</b>
☺	☺	☺	☺	☺	664 519 997	<b>674,07 €</b>



# Vysokotlakové čističe











# vysokotlakové čističe

		HP-351 HP-401	Objednávacie číslo	MOC EUR s DPH
	Striekacia pištoľ	☺	197842-2	<b>15,31 €</b>
	Aretovateľná dýza	☺	197822-8	<b>8,39 €</b>
	Dýza	☺	197876-5	<b>17,58 €</b>
	Turbo tryska	☺	197824-4	<b>8,96 €</b>
	Zahnutá tryska	☺	197859-5	<b>22,68 €</b>
	Čistiaca sada	☺	197879-9	<b>1,36 €</b>
	Predlžovacie nástavce	☺	197870-7	<b>35,83 €</b>
	Rotačná kefa	☺	197831-7	<b>12,25 €</b>
	Kefa	☺	197828-6	<b>6,12 €</b>
	Napeňovač	☺	197886-2	<b>13,95 €</b>

		HP-351 HP-401	Objednávacie číslo	MOC EUR s DPH
	Kefa	☺	197864-2	<b>15,20 €</b>
	Hadica na čistenie potrubia 10 m	☺	197837-5	<b>19,62 €</b>
	Hadica na čistenie potrubia 15 m	☺	197840-6	<b>24,61 €</b>
	Vysokotlaková hadica 5 m	☺	197845-6	<b>21,55 €</b>
	Vysokotlaková hadica 8 m	☺	197847-2	<b>29,71 €</b>
	Vysokotlaková hadica 10 m	☺	197850-3	<b>35,15 €</b>
	Spojka	☺	197867-6	<b>10,89 €</b>
	Sacia hadica	☺	197873-1	<b>24,72 €</b>
	Spojka	☺	197853-7	<b>4,76 €</b>
	Nadstavec na ventil	☺	197881-2	<b>3,29 €</b>
Spojka na prívodnú hadicu	☺	197883-8	<b>3,29 €</b>	

# vysokotlakové čističe

		HP-20	HP-300	HP-350	HP-450	HP-7000	Objednávacie číslo	MOC EUR s DPH
	Striekacia pištoľ	☺	☺	☺			3320152	<b>4,99 €</b>
	Striekacia pištoľ				☺		3640920	<b>16,18 €</b>
	Striekacia pištoľ					☺	41154	<b>18,29 €</b>
	Aretovateľná dýza	☺					609 640 640	<b>2,04 €</b>
	Aretovateľná dýza		☺	☺			3640650	<b>2,39 €</b>
	Aretovateľná dýza				☺		3640960	<b>40,52 €</b>
	Aretovateľná dýza					☺	40246	<b>17,59 €</b>
	Turbo tryska	☺	☺	☺			609 041 193	<b>8,82 €</b>
	Turbo tryska				☺		609 041 195	<b>11,76 €</b>
	Turbo tryska					☺	609 041 217	<b>55,76 €</b>
	Vysokotlaková hadica 5m	☺					3640630	<b>6,30 €</b>
	Vysokotlaková hadica 8m		☺	☺	☺		609 041 199	<b>61,30 €</b>
	Vysokotlaková hadica 8m					☺	609 041 201	<b>62,22 €</b>
	Hadica na čistenie potrubia 10 m	☺	☺	☺	☺	☺	40863	<b>32,35 €</b>

		HP-20	HP-300	HP-350	HP-450	HP-7000	Objednávacie číslo	MOC EUR s DPH
	Hadica na čistenie potrubia 16 m	☺	☺	☺	☺	☺	609 041 205	<b>112,18 €</b>
	Sacia súprava	☺	☺	☺	☺	☺	609 041 207	<b>48,76 €</b>
	Kefa	☺	☺	☺	☺	☺	609 041 209	<b>16,17 €</b>
	Kefa na podlahy	☺	☺	☺	☺		41150	<b>32,58 €</b>
	Filter na vodu	☺	☺	☺	☺	☺	609 040 855	<b>14,79 €</b>
	Filter na vodu	☺	☺	☺	☺	☺	3082130	<b>0,90 €</b>
	Kefa na podlahy s nádržkou na čistiaci prostriedok					☺	41849	<b>53,87 €</b>
	Univerzálny čistič 1 L	☺	☺	☺	☺	☺	40724	<b>11,12 €</b>

# vysokotlakové čističe

		HP-10	HP-115	HP-135	HP-1500	Objednávacie číslo	MOC EUR s DPH
	Striekacia pištoľ	☺				40797	<b>10,91 €</b>
	Aretovalná dýza	☺				40798	<b>5,67 €</b>
	Aretovalná dýza		☺			609 040 878	<b>13,88 €</b>
	Aretovalná dýza			☺		40879	<b>12,20 €</b>
	Aretovalná dýza				☺	609 040 886	<b>24,16 €</b>
	Turbo tryska		☺			609 040 880	<b>12,50 €</b>
	Turbo tryska			☺		40721	<b>10,22 €</b>
	Turbo tryska				☺	40867	<b>35,14 €</b>
	Vysokotlaková hadica 3 m	☺				40799	<b>11,75 €</b>
	Vysokotlaková hadica 5,5m		☺			609 040 856	<b>19,92 €</b>
	Vysokotlaková hadica 7,5m			☺		609 040 857	<b>28,60 €</b>
	Vysokotlaková hadica 15m				☺	609 040 858	<b>134,52 €</b>
	Hadica na čistenie potrubia 8 m		☺	☺		40863	<b>32,35 €</b>
	Hadica na čistenie potrubia 16 m		☺	☺		609 041 205	<b>112,18 €</b>
	Hadica na čistenie potrubia 8 m				☺	609 040 865	<b>41,17 €</b>



		HP-10	HP-115	HP-135	HP-1500	Objednávacie číslo	MOC EUR s DPH
	Hadica na čistenie potrubia 16 m				☺	609 040 866	<b>69,06 €</b>
	Sacia súprava		☺	☺		609 040 859	<b>28,30 €</b>
	Sacia súprava				☺	609 040 860	<b>30,13 €</b>
	Kefa	☺	☺	☺		609 040 869	<b>21,68 €</b>
	Kefa				☺	609 040 870	<b>12,85 €</b>
	Rotačná kefa		☺	☺		609 040 896	<b>26,23 €</b>
	Rotačná kefa				☺	609 040 897	<b>21,00 €</b>
	Filter na vodu		☺	☺	☺	609 040 855	<b>14,79 €</b>
	Kefa na podlahy		☺	☺		609 040 874	<b>89,58 €</b>
	Kefa na podlahy				☺	609 040 876	<b>57,15 €</b>
	Kefa na podlahy s nádržkou na čistiaci prostriedok		☺	☺		609 040 875	<b>108,06 €</b>
	Kefa na podlahy s nádržkou na čistiaci prostriedok				☺	40877	<b>69,06 €</b>



# Akumulátorové LI-Ion náradie



# akku píly

## REŽAZE PRE AKKU PÍLY



		Dĺžka lišty	Delenie pílovej reťaze	Šírka drážky	Profil zubu	Objednávacie číslo	MOC EUR s DPH
	AS-1212 AS-1812 AS-1813	11,5 cm	1/4"	1,3 mm	HM	572 466 742	<b>11,84 €</b>
	AS-3625 AS-3626 AS-3726	25 cm	3/8"	1,3 mm	HM	511 492 740	<b>9,71 €</b>
	AS-3731	30 cm	3/8"	1,1 mm	HM	196 740-7	<b>8,87 €</b>
	AS-3835	35 cm	3/8"	1,1 mm	HM	511 291 752	<b>11,62 €</b>
	AS-3626 C AS-3835	25 cm	1/4"	1,1 mm	HM	512 466 760*	<b>16,11 €</b>

\* záberové kolo obj. číslo 198 259-2

# akku píly

## LIŠTY PRE AKKU PÍLY



		Dĺžka lišty	Delenie pílovej reťaze	Šírka drážky	Objednávacie číslo	MOC EUR s DPH
	AS-1212 AS-1812 AS-1813	11,5 cm	1/4"	1,3 mm	660 158 479	<b>25,29 €</b>
	AS-3625 AS-3626 AS-3726	25 cm	3/8"	1,3 mm	168 406-9	<b>9,27 €</b>
	AS-3731	30 cm	3/8"	1,1 mm	165 426-4	<b>5,40 €</b>
	AS-3835	35 cm	3/8"	1,1 mm	412 035 611	<b>11,77 €</b>
	AS-3626 C AS-3835	25 cm	1/4"	1,1 mm	168 395-8*	<b>50,13 €</b>

\* záberové kolo obj. číslo 198 259-2

# akku krovinořezy



## žacie hlavy pre akku krovinořezy

		Priemer lanka	AT-3624 LGE AT-1831 AT-1832 AT-3723 AT-3731 AT-3724 AT-3735 C AT-3736 C	AT-1826	AT-1826 H AT-1827 H	Objednávacie číslo	MOC EUR s DPH
	Cievka žacej hlavy			☺	☺	195 859-9	<b>4,80 €</b>
	Automatická	2,4 mm	☺			B-02945	<b>22,17 €</b>

## žacie nože pre akku krovinořezy

		AT-3624 LGE AT-3724 AT-3723 AT-3731	Objednávacie číslo	MOC EUR s DPH
	Plastový nôž 255 mm	☺	197188-6	<b>20,54 €</b>
	Náhradné plastové nože /12ks/	☺	197189-4	<b>10,94 €</b>
	4 zubový žací nôž 230 × 25,4	☺	362 224 140	<b>11,58 €</b>

## nože pre AR-3733/DUP361

		AR-3733/DUP361	Objednávacie číslo	MOC EUR s DPH
	Nôž spodný	☺	197367-6	<b>37,77 €</b>
	Nôž vrchný	☺	197366-8	<b>38,45 €</b>

Nože sú dodávané bez skrutiek a hriadele.

# akku

popruhy pre akku krovinořezy

		AT-3624 LGE	Objednávacie číslo	MOC EUR s DPH
	Dvojamenný popruh.	☺	122907-1	<b>17,01 €</b>

žacie nože pre akku kosačky

		AM-3643 LG	AM-3738	AM-3743	Objednávacie číslo	MOC EUR s DPH
	žací nôž	☺			660 196 060	<b>24,92 €</b>
	žací nôž		☺		196863-1	<b>10,81 €</b>
	žací nôž			☺	197762-0	<b>10,35 €</b>



nože pre akku kultivátor

		AK-3622	Objednávacie číslo	MOC EUR s DPH
	Nôž ľavá strana časť A	☺	126 169-3	<b>119,50 €</b>
	Nôž ľavá strana časť B	☺	126 196-0	<b>103,15 €</b>
	Nôž pravá strana časť A	☺	126 167-7	<b>119,50 €</b>
	Nôž pravá strana časť B	☺	126 195-2	<b>103,15 €</b>

Nože sú dodávané bez skrutiek a hriadele.

# akku plotostrihy/nožnice na trávu

žacie nože pre akku plotostrihy/nožnice na trávu

	AH-3656 AH-3756	AH-3766	AH-1842	AH-1848	AH-1852	AH-1852 H AH-1853 H	AX-1820	AX-1820 H AX-1821 H	UH200D AH-1020LGEX	UM164D	Objednávacie číslo	MOC EUR s DPH
		☺ 650 mm									194674-8	70,78 €
	☺										194 672-2	49,54 €
							☺				195 242-0	32,96 €
			☺ 420 mm								660 195 770	49,36 €
				☺ 480 mm							660 195 771	52,62 €
					☺ 520 mm						660 195 772	54,02 €
						☺ 520 mm			☺		195772-1	30,67 €
								☺			195272-1	22,31 €
								☺			195243-8	21,95 €
								☺	☺		195242-0	32,96 €
								☺			195267-4	35,72 €

kryty nožov pre akku plotostrihy/nožnice na trávu



	AH-3656 AH-3756	AH-3766	UH200D AH-1020LGEX	UM164D	Objednávacie číslo	MOC EUR s DPH
	☺				450491-9	2,16 €
		☺			450492-7	3,40 €
			☺		451816-0	1,73 €
				☺	452055-5	1,82 €

zachytávač odrezkov pre akku plotostrihy/nožnice na trávu

	AH-3656 AH-3756	UH200D AH-1020LGEX	AX-1820 H AX-1821 H	UM164D	Objednávacie číslo	MOC EUR s DPH
	☺				194681-1	16,03 €
		☺			451880-1	1,40 €
				☺	325896-1	2,60 €
			☺	☺	195229-2	45,03 €



# akku dúchadlá / postrekovače





		AG-3628 AG-3629	AG-3750	AG-3729	Objednávacie číslo	MOC EUR s DPH
	Nadstavec			☺	452123-4	<b>7,47 €</b>
			☺		455916-8	<b>7,59 €</b>
		☺			452124-2	<b>7,92 €</b>
	Popruh		☺		166094-6	<b>3,33 €</b>
		☺		☺	166095-4	<b>3,72 €</b>

akku postrekovač SP-1815

		Objednávacie číslo	MOC EUR s DPH
	Nadstavec	695 950 5801	<b>10,74 €</b>
	Dýza dvojité	694 900 1000	<b>16,39 €</b>
	Dýza široká	690 803 1000	<b>5,77 €</b>
	Dýza herbicíd	695 801 1000	<b>5,71 €</b>
	Dýza dvojité tvar Y	695 802 5000	<b>12,74 €</b>

# akumulátory, nabíjačky

		AM-3643 LG	AS-3625 AS-3626/C AT-3624 LGE AH-3656	AX-1820, AY-1820, AT-1826,	AH-1842, AH-1848, AH-1852	AG-3628	AT-3723 U AM-3738 Z AM-3743 Z AG-3750 AR-3733 AT-1831 AT-1832 AT-3723 U AT-3731 AT-3735 C AT-3736 C AS-3835	AS-1812 LGE	SP-1815 BVF104RF	UH200DWX AH-1020LGE	AT-1826/7 H AX-1820/1 H AH-1852/3 H AH-3756 / 66 AG-3729 AS-3726	AK-3622	Objednávacie číslo	MOC EUR s DPH
	baterka 36 V 2,2 Ah	☺	☺			☺						☺	195410-5	206,15 €
	baterka 18 V 3,0 Ah						☺	☺	☺		☺		194490-8	76,68 €
	baterka 18 V 4,0 Ah						☺	☺	☺		☺		197265-4	81,19 €
	baterka 18 V 5,0 Ah						☺	☺	☺		☺		197280-8	89,10 €
	baterka 18 V 6,0 Ah						☺	☺	☺		☺		197422-4	91,53 €
	baterka 18 V 1,3 Ah										☺		194513-2	69,25 €
	baterka 18 V 1,3 Ah			☺	☺								196372-0	41,99 €
	baterka 10,8V 1,3 Ah										☺		194550-6	31,62 €

		AM-3643 LG	AS-3625 AS-3626/C AT-3624 LGE AH-3656	AX-1820, AY-1820, AT-1826,	AH-1842, AH-1848, AH-1852	AG-3628	AT-3723 U AM-3738 Z AM-3743 Z AG-3750 AR-3733 AT-1831 AT-1832 AT-3723 U AT-3731 AT-3735 C AT-3736 C AS-3835	AS-1812 LGE	SP-1815 BVF104RF	UH200DWX AH-1020LGEX	AT-1826/7 H AX-1820/1 H AH-1852/3 H AH-3756 / 66 AG-3729 AS-3726	AK-3622	Objednávacie číslo	MOC EUR s DPH
	nabíjačka 36 V, 2,2 Ah	☺	☺			☺						☺	195478-1	<b>78,28 €</b>
	nabíjačka 18 V, 1,3 / 3,0 / 4,0 / 5,0 / 6,0 Ah						☺	☺	☺		☺		660 122 211	<b>102,88 €</b>
	nabíjačka 18 V 1,1 Ah			☺	☺								195751-9	<b>37,67 €</b>
	nabíjačka 10,8 V									☺			194588-1	<b>36,41 €</b>
	nabíjačka 2x 18 V 1,3 / 3,0 / 4,0 / 5,0 / 6,0 Ah						☺	☺	☺		☺		196942-5	<b>126,90 €</b>
	predĺžovací adaptér 36 V		☺			☺							195311-7	<b>31,77 €</b>
	adaptér 2x 18 / 36 V		☺			☺							195511-9	<b>90,80 €</b>



# Ostatné príslušenstvo



# nože pre plotostrihy



















pre elektrické plotostrihy

	HT-42	HT-43	HT-48	HT-49	HT-52	HT-53	HT-345	HT-355	HT-365	HT-5510	HT-6510	HT-7510	Objednávacie číslo	MOC EUR s DPH
	☺												660 280 208	48,08 €
			☺										660 280 209	51,47 €
					☺								660 280 210	57,00 €
							☺						344 194 661	43,96 €
								☺					194 664-1	13,71 €
									☺				344 194 667	51,52 €
		☺											140 826-9	24,56 €
				☺									660 140 830	51,47 €
						☺							660 140 827	57,00 €
										☺			194 672-2	49,54 €
											☺		194 674-8	70,78 €
												☺	660 194 676	93,20 €
							☺	☺	☺	☺	☺	☺	194681-1	16,03 €

# nože pre plotostrihy



pre benzínové plotostrihy

	HT-2249 D	HT-2375 D	HT-2475	MH-2556	HT-2950	HT-2975	HT-2556 D	HT-2576 E	HT-2350 D	HT-2360 D	Objednávacie číslo	MOC EUR s DPH
	☺										374 522 000 <sup>horný</sup>	53,71 €
	☺										374 522 000 <sup>spodný</sup>	53,71 €
		☺									725 171-9 <sup>horný</sup>	46,71 €
		☺									725 171-9 <sup>spodný</sup>	46,71 €
			☺								725163-8 <sup>horný</sup>	28,91 €
			☺								725 164-6 <sup>spodný</sup>	29,43 €
				☺							224143009A	49,29 €
					☺						342 230 050	67,02 €
						☺					342 230 070	88,24 €
									☺		725 169-6 <sup>horný</sup>	42,59 €
									☺		725169-6 <sup>spodný</sup>	42,59 €
										☺	725 170-1 <sup>horný</sup>	39,01 €
										☺	725170-1 <sup>spodný</sup>	39,01 €
							☺				6 018 505 400 <sup>horný</sup>	28,36 €
							☺				6 018 505 500 <sup>spodný</sup>	28,36 €
								☺			6 018 505 200 <sup>horný</sup>	23,63 €
								☺			6 018 505 301 <sup>spodný</sup>	23,63 €

# PD-520 R













		Objednávacie číslo	MOC EUR s DPH
	Vrták Ø 80 mm × 800 mm	720 020	<b>71,41 €</b>
	Vrták Ø 100 mm × 800 mm	720 040	<b>72,36 €</b>
	Vrták Ø 120 mm × 800 mm	720 070	<b>77,11 €</b>
	Vrták Ø 150 mm × 800 mm	720 170	<b>78,84 €</b>
	Vrták Ø 180 mm × 800 mm	720 210	<b>84,27 €</b>
	Vrták Ø 200 mm × 800 mm	720 350	<b>86,83 €</b>
	Vrták Ø 250 mm × 800 mm	727 430	<b>140,40 €</b>
	Predlžovací nadstavec 400 mm	750 360	<b>39,90 €</b>



# hroty na vrtáky





		Objednávacie číslo	MOC EUR s DPH
	Nôž rycí 80 mm	600 470	10,16 €
	Nôž rycí 100 mm	600 150	10,52 €
	Nôž rycí 120 mm	600 450	9,53 €
	Nôž rycí 150 mm	600 170	9,81 €
	Nôž rycí 180 mm	600 460	10,21 €
	Nôž rycí 200 mm	600 180	10,43 €
	Nôž rycí 250 mm	600 190	12,12 €
	Hrot na vrták	750 750	11,28 €
	Skrutka na uchytenie rycieho noža	030 730	0,26 €
	Matka na uchytenie rycieho noža	060 030	0,16 €
	Podložka na uchytenie rycieho noža	090 080	0,16 €

## príslušenstvo pre vodné pumpy

		Objednávacie číslo	MOC EUR s DPH
	Hadica 8 m + dýza pre MP-352.4, MP-245.4Z, MP-335.4Z	B-10671	<b>83,98 €</b>

## príslušenstvo pre zametač podláh

		Objednávacie číslo	MOC EUR s DPH
	Kefa centrálna pre WK-80	620 094 002	<b>36,94 €</b>
	Kefa bočná pre WK-80	620 094 042	<b>26,96 €</b>

## príslušenstvo pre fukár

		Objednávacie číslo	MOC EUR s DPH
	Sada na odsávanie pre PB-250,4 / PB-252,4	197235-3	<b>47,50 €</b>







# štiepacie kliny A PRÍSLUŠENSTVO



		Objednávacie číslo	MOC EUR s DPH
	Rozšírený pozinkovaný štiepací klin pre ľahšie štiepanie. Vhodný na model: LS-6002, LS-6004, LS-9004.	610 248 010	<b>162,17 €</b>
	Krížový pozinkovaný štiepací klin, rozštiepi drevo rovno na 4 časti. Vhodný na model: LS-6002, LS-6004, LS-9004.	610 248 020	<b>162,17 €</b>
	Predlžovací pozinkovaný, štiepací klin – 280 mm. Vhodný na model: LS-6002, LS-6004, LS-9004.	615 248 030	<b>377,46 €</b>













SP-7650.4 R

		Objednávacie číslo	MOC EUR s DPH
	Dýza (0,7/0,8)	196499-6	<b>6,48 €</b>
	Dýza (0,5)	196616-8	<b>3,69 €</b>
	Rúra 630	453699-4	<b>3,83 €</b>
	Rúra 380	453700-5	<b>4,82 €</b>
	Rúra zahnutá 630	453507-9	<b>4,20 €</b>

		Objednávacie číslo	MOC EUR s DPH
	Ochranná podložka 200 × 400 mm (utierka sajúca olej).	988 959 500	<b>0,64 €</b>
	Nástroj na čistenie rebier valca.	944 500 795	<b>1,23 €</b>
	Predlžovacia šnúra 230 V, 25 m, HO 7 RN-F.	988 311 000	<b>50,86 €</b>
	Merač vlhkosti kmeňov MM-400. 5%–40%	988 050 516	<b>18,17 €</b>
	Pílťový kotúč chrómový 700 × 30 mm.	621 052 572	<b>232,07 €</b>
	Pílťový kotúč z tvrdeného kovu 700 × 30 mm.	615 258 010	<b>430,60 €</b>











# 4-taktný postrekovač



	SP-252.4 R	Objednávacie číslo	MOC EUR s DPH
	Hadica	6909039001	<b>9,55 €</b>
	Nadstavec	6909511501	<b>8,39 €</b>
	Dýza dvojitá	6949001000	<b>16,39 €</b>
	Dýza široká	6908031000	<b>5,77 €</b>
	Dýza herbicíd	6958011000	<b>5,71 €</b>
	Dýza dvojitá tvar Y	6958025000	<b>12,74 €</b>
	Dýza dvojitá tvar U	6958018000	<b>8,01 €</b>
	Dýza trojitá	6909500100	<b>14,17 €</b>
	Dýza štvoritá	6919500000	<b>20,13 €</b>
	Dýza kompaktná	6939025000	<b>98,37 €</b>
	Dýza postreková	6939024000	<b>138,11 €</b>
	Dýza postreková super	6939028000	<b>107,05 €</b>









# kliny, sekery, nožnice



		Objednávacie číslo	MOC EUR s DPH
	Klin plastový 14 cm.	945 900 001	<b>9,51 €</b>
	Klin plastový 20 cm.	988 070 819	<b>7,11 €</b>
	Klin plastový 25 cm.	988 070 824	<b>7,62 €</b>
	Klin plastový.	988 070 070	<b>30,93 €</b>
	Klin hliníkový – točený.	988 070 090	<b>41,04 €</b>
	Klin hliníkový – duralový 26 cm.	988 070 101	<b>34,29 €</b>
	Sekera 37 cm, 800 g	988 049 300	<b>38,66 €</b>
	Sekera 73 cm, 1 900 g	988 049 301	<b>61,00 €</b>
	Sekera 73 cm, 2 500 g	988 049 302	<b>78,45 €</b>
	Teleskopické nožnice 67–99 cm, do priemeru 45 mm	988 049 303	<b>39,97 €</b>











# kliny



		Objednávacie číslo	MOC EUR s DPH
	Klin drevený, špic, krúžok.	988 070 010	28,95 €
	Hliníkový krúžok na klin.	988 070 040	5,57 €
	Klin z tvrdého dreva pre nasadzovanie násad na sekery a sapíny 68 mm. Sapína – tyč s kovaním používaná pri manipulácii s kmeňmi.	988 090 070	0,82 €
	Klin z tvrdého dreva pre nasadzovanie násad na sekery, kladivá 43 mm.	988 090 090	0,63 €
	Klin z tvrdého dreva pre nasadzovanie násad na sekery, kladivá 50 mm.	988 090 080	0,63 €
	Kruhový klin 10 × 1,5 mm. Klíny zatláčajú drevo do každej strany. Týmto sa dosiahne dobré držanie pri nasadzovaní na násadu každého druhu. Aby ste dosiahli veľmi dobré držanie, stláčajte drevo smerom von. Balenie: 10 ks.	988 070 130	2,37 €
	Kruhový klin 14 × 2,0 mm. Klíny zatláčajú drevo do každej strany. Týmto sa dosiahne dobré držanie pri nasadzovaní na násadu každého druhu. Aby ste dosiahli veľmi dobré držanie, stláčajte drevo smerom von. Balenie: 10 ks.	988 070 120	3,36 €
	Kruhový klin 18 × 2,5 mm. Klíny zatláčajú drevo do každej strany. Týmto sa dosiahne dobré držanie pri nasadzovaní na násadu každého druhu. Aby ste dosiahli veľmi dobré držanie, stláčajte drevo smerom von. Balenie: 10 ks.	988 070 110	5,44 €

# príslušenstvo











		Objednávacie číslo	MOC EUR s DPH
	Obracač kmeňov 80 cm.	988 048 080	<b>61,99 €</b>
	Obracač kmeňov 130 cm.	988 048 130	<b>88,58 €</b>
	Hák pre obracač kmeňov.	988 048 131	<b>17,00 €</b>
	Držiak háku pre obracač kmeňov.	988 048 132	<b>6,48 €</b>
	Kliešte na drevo do 1 500 kg. Rozpätie 550 mm.	988 110 580	<b>166,80 €</b>
	Kliešte na drevo do 1 500 kg. Rozpätie 700 mm.	988 110 700	<b>212,59 €</b>
	Kliešte na drevo do 1 000 kg. Rozpätie 560 mm.	988 115 580	<b>159,95 €</b>
	Kliešte na drevo. Rozpätie 190 mm.	988 048 053	<b>41,67 €</b>
	Hák na obracanie dreva. Držadlo typu D.	988 048 052	<b>33,26 €</b>
	Hák na obracanie dreva.	988 048 051	<b>23,09 €</b>



# príslušenstvo



		Objednávacie číslo	MOC EUR s DPH
	Hák na ťahanie dreva	988 090 100	<b>46,16 €</b>
	Hák na ťahanie dreva	988 090 200	<b>42,92 €</b>
	Merač kmeňov 40 cm	988 052 040	<b>77,67 €</b>
	Meracie pásмо 15 m	988 050 615	<b>53,42 €</b>
	Meracie pásмо 20 m	988 050 620	<b>60,48 €</b>
	Meracie pásмо 25 m	988 050 625	<b>63,50 €</b>
	Nitovacie kliešte + 500 ks nitov.	988 050 651	<b>94,05 €</b>
	Označovacia krieda čierna 12 ks/bal	988 050 720	<b>9,74 €</b>

# príslušenstvo



		Objednávacie číslo	MOC EUR s DPH
	Označovacia krieda červená 12 ks/bal	988 050 680	<b>10,77 €</b>
	Označovacia krieda žltá 12 ks/bal	988 050 690	<b>10,94 €</b>
	Označovacia krieda modrá 12 ks/bal	988 050 730	<b>10,67 €</b>
	Označovací sprej červený 500 ml	988 050 810	<b>7,65 €</b>
	Označovací sprej modrý 500 ml	988 050 820	<b>7,66 €</b>
	Označovací sprej zelený 500 ml	988 050 801	<b>7,78 €</b>
	Označovací sprej oranžový 500 ml	988 050 805	<b>7,65 €</b>
	Označovací sprej biely 500 ml	988 050 802	<b>7,69 €</b>
	Počítadlo 0–9999	988 050 653	<b>19,07 €</b>

		Objednávacie číslo	MOC EUR s DPH
	Laserový merač 0,3 – 1,5 m. Pre modely PS-5000, PS-4600 S, PS-500, PS-460	988 050 513	<b>192,02 €</b>

# príslušenstvo





		Objednávacie číslo	MOC EUR s DPH
	Skrutkovač račňa.	988 050 212	12,54 €
	Sada príslušenstva k motorovej píle (19 ks).	988 050 210	31,39 €
	Skrutkovač račňa so sadou bitov (17 ks).	988 050 213	30,43 €
	Sada príslušenstva (103 ks).	988 050 215	105,43 €



		Objednávacie číslo	MOC EUR s DPH
	Orezávací nožík Dolmar, 10 ks náhradných plátkov v balení.	988 048 024	8,75 €

		Objednávacie číslo	MOC EUR s DPH
	Lopata na odhŕňanie snehu Dolmar.	988 050 219 <small>/do vypredania zásob/</small>	17,64 €





# prilby

		Objednávacie číslo	MOC EUR s DPH
	Profesionálna prilba so sluchátkami a ochrannou sieťkou. Veľkosť ôk sieťky 1,8 × 2,5 mm SNR 26 dB. Veľkosť 53–61.	988 000 006	<b>66,22 €</b>
	Profesionálna prilba. Veľkosť 53–61.	988 000 010	<b>19,81 €</b>
	Profesionálna prilba. Veľkosť 54–62.	988 000 018	<b>20,02 €</b>
	Ochranná prilba so sluchátkami a ochrannou sieťkou. Veľkosť ôk sieťky 1 × 1mm SNR 23 dB. Veľkosť 54–62.	988 000 005	<b>33,71 €</b>

# prilby





		Objednávacie číslo	MOC EUR s DPH
	Profesionálna prilba „PROFI PLUS“	988 000 041	<b>65,08 €</b>
	Ochranná sieťka pre prilbu 988 000 041/988 000 010 (V4b 0,3mm, veľkosť ôk sieťky 1 × 1 mm)	988 000 054	<b>18,24 €</b>
	Ochranné sluchátka pre prilbu 988 000 041 / 988 000 010 (CE SNR 26 dB (A))	988 000 030	<b>28,09 €</b>

# prilby

		Objednávacie číslo	MOC EUR s DPH
	Profesionálna prilba „G22d“	988 000 042	<b>79,03 €</b>
	Ochranná sieťka pre prilbu 988 000 042 / 988 000 018 (5B, veľkosť ôk sieťky 1 × 1 mm)	988 000 037	<b>14,93 €</b>
	Ochranné sluchátka pre prilbu 988 000 042 / 988 000 018 (CE SNR 26 dB (A))	988 000 030	<b>28,09 €</b>
	Držiak na sieťku pre prilbu 988 000 042 / 988 000 018	988 000 033	<b>11,15 €</b>





# ochranné sieťky



		Objednávacie číslo	MOC EUR s DPH
	Ochranná sieťka. Veľkosť ôk sieťky 1,8 × 2,5 mm. Na sluchátka s objednávacím číslom 988 000 030.	988 000 023	<b>17,78 €</b>
	Ochranná sieťka. Veľkosť ôk sieťky 1,8 × 1,8 mm. Na sluchátka s objednávacím číslom 988 000 030.	988 000 050	<b>16,15 €</b>
	Ochranná sieťka. Veľkosť ôk sieťky 1 × 1 mm. Na sluchátka s objednávacím číslom 988 000 030.	988 000 054	<b>18,24 €</b>
	Ochranná sieťka. Veľkosť ôk sieťky 1,8 × 2,5 mm. Na sluchátka s objednávacím číslom 988 000 030.	988 000 055	<b>18,81 €</b>
	Ochranná sieťka z odľahčeného kovu. Na sluchátka s objednávacím číslom 988 000 030.	988 000 053	<b>29,20 €</b>

# ochranné pomôcky



		Objednávacie číslo	MOC EUR s DPH
	Ochranný kryt tváre	751 840	5,68 €
	Ochranné plexisklo pre 988 000 051	988 000 026	28,86 €
	Profesionálne ochranné sluchátka. SNR 26 dB	988 000 040	26,39 €
	Ochranné sluchátka. SNR 23 dB.	988 000 045	8,47 €











# ochranné pomôcky



		Objednávacie číslo	MOC EUR s DPH
	Profesionálne ochranné sluchátka. SNR 26 dB.	988 000 030	28,09 €
	Sluchadlová vložka na sluchátka 988 000 040 a 988 000 030.	988 000 067	11,00 €
	Náhradný klip na sluchátka 988 000 030.	988 000 064	7,28 €
	Náhradná výstuha do prilby. Pre prilby s objednávacím číslom: 988 000 018 a 988 000 011.	988 000 065	13,82 €
	Náhradná výstuha do prilby. Pre prilby s objednávacím číslom: 988 000 006, 988 000 009, 988 000 010.	988 000 066	14,06 €
	Ochranné okuliare	988 000 062	24,84 €
	Ochranné okuliare	988 000 063	14,56 €

# ochranné pomôcky



		Objednávacie číslo	MOC EUR s DPH
	Ochranné okuliare	192219-6	2,05 €
	Čistiace handričky	988 959 550	19,46 €
	Ohradzovacia stuha 500 m	988 050 627	19,16 €
	Protiporezové pilčičke rukavice	988 000 103	37,81 €
	Pilčičke rukavice „UNIVERZAL“ veľkosť S	988 000 407	13,13 €
	Pilčičke rukavice „UNIVERZAL“ veľkosť M	988 000 408	13,86 €
	Pilčičke rukavice „UNIVERZAL“ veľkosť L	988 000 409	13,33 €
	Pilčičke rukavice „UNIVERZAL“ veľkosť XL	988 000 410	13,52 €
	Pilčičke rukavice „UNIVERZAL“ veľkosť XXL	988 000 411	13,42 €







# ochranné pomôcky



		Objednávacie číslo	MOC EUR s DPH
	Pilčičke rukavice „PROFESIONAL“ veľkosť S	988 000 507	<b>16,86 €</b>
	Pilčičke rukavice „PROFESIONAL“ veľkosť M	988 000 508	<b>16,61 €</b>
	Pilčičke rukavice „PROFESIONAL“ veľkosť L	988 000 509	<b>24,55 €</b>
	Pilčičke rukavice „PROFESIONAL“ veľkosť XL	988 000 510	<b>17,24 €</b>
	Pilčičke rukavice „PROFESIONAL“ veľkosť XXL	988 000 511	<b>23,44 €</b>
	Profesionálne pracovné rukavice. Veľkosť 8	988 000 208	<b>10,74 €</b>
	Profesionálne pracovné rukavice. Veľkosť 9	988 000 209	<b>10,93 €</b>
	Profesionálne pracovné rukavice. Veľkosť 10	988 000 210	<b>11,39 €</b>
	Profesionálne pracovné rukavice. Veľkosť 12	988 000 212	<b>10,73 €</b>
	Pracovné rukavice „WORKER PRO“ veľkosť M	988 000 111	<b>10,45 €</b>
	Pracovné rukavice „WORKER PRO“ veľkosť L	988 000 112	<b>10,39 €</b>
	Pracovné rukavice „WORKER PRO“ veľkosť XL	988 000 113	<b>10,37 €</b>
	Pracovné rukavice „WORKER PRO“ veľkosť XXL	988 000 114	<b>10,38 €</b>

# ochranné pomôcky



		Objednávacie číslo	MOC EUR s DPH
	Pracovné rukavice	988 000 100	<b>1,92 €</b>
	Termo rukavice. Veľkosť 9.	988 000 309	<b>6,53 €</b>
	Termo rukavice. Veľkosť 10.	988 000 310	<b>6,54 €</b>
	Termo rukavice. Veľkosť 11.	988 000 311	<b>6,56 €</b>
	Gurtňa 25mm / 1,85 m do 250 kg	988 070 710	<b>12,96 €</b>
	Gurtňa 50 mm / 3 m do 500 kg	988 070 711	<b>26,38 €</b>
	Reflexná vesta	988 048 011	<b>7,37 €</b>





# štartovacie sady

## PRACOVNÝCH POMÔCOK



		Objednávacie číslo	MOC EUR s DPH
	Sada pracovných pomôcok pre pilčíkov: pracovné nohavice, ochranná prilba so sluchátkami a ochrannou sieťkou tváre, rukavice. Veľkosť 50/52 (M).	988 001 010	<b>104,00 €</b>
	Sada pracovných pomôcok pre pilčíkov: pracovné nohavice, ochranná prilba so sluchátkami a ochrannou sieťkou tváre, rukavice. Veľkosť 54/56 (L).	988 001 011	<b>111,07 €</b>
	Sada pracovných pomôcok pre pilčíkov: pracovné nohavice, ochranná prilba so sluchátkami a ochrannou sieťkou tváre, rukavice. Veľkosť 58/60 (XL).	988 001 013	<b>118,77 €</b>



# oblečenie na voľný čas

		Objednávacie číslo	MOC EUR s DPH
	Mikina červená, 65% polyester, 35% bavlna. Veľkosť XL	DW11125 RD	<b>42,15 €</b>
	Polokošela čierna. Veľkosť XL	DW21220 BK	<b>17,50 €</b>
	Polokošela červená. Veľkosť XL	DW21220 RD	<b>17,50 €</b>
	Tričko čierne, 100% bavlna. Veľkosť XXL	DW34225 BK	<b>14,04 €</b>

# profesionálne pracovné nohavice

		Objednávacie číslo	MOC EUR s DPH
	Pracovné nohavice „Superior“ Veľkosť 48	988 124 048	<b>114,29 €</b>
	Pracovné nohavice „Superior“ Veľkosť 50	988 124 050	<b>293,59 €</b>
	Pracovné nohavice „Superior“ Veľkosť 52	988 124 052	<b>293,59 €</b>
	Pracovné nohavice „Superior“ Veľkosť 54	988 124 054	<b>293,59 €</b>
	Pracovné nohavice „Superior“ Veľkosť 58	988 124 058	<b>293,59 €</b>
	Pracovné nohavice „Super Plus“ Veľkosť 46	988 129 046	<b>169,04 €</b>
	Pracovné nohavice „Super Plus“ Veľkosť 48	988 129 048	<b>169,04 €</b>
	Pracovné nohavice „Super Plus“ Veľkosť 50	988 129 050	<b>169,04 €</b>
	Pracovné nohavice „Super Plus“ Veľkosť 52	988 129 052	<b>169,04 €</b>
	Pracovné nohavice „Super Plus“ Veľkosť 54	988 129 054	<b>169,04 €</b>
	Pracovné nohavice „Super Plus“ Veľkosť 56	988 129 056	<b>169,04 €</b>



# profesionálne pracovné nohavice

		Objednávacie číslo	MOC EUR s DPH
	Pracovné nohavice „Profesional“ veľkosť 26	988 131 026	<b>192,71 €</b>
	Pracovné nohavice „Profesional“ veľkosť 27	988 131 027	<b>192,71 €</b>
	Pracovné nohavice „Profesional“ veľkosť 28	988 131 028	<b>211,91 €</b>
	Pracovné nohavice „Profesional“ veľkosť 29	988 131 029	<b>211,91 €</b>
	Pracovné nohavice „Profesional“ veľkosť 46	988 131 046	<b>188,62 €</b>
	Pracovné nohavice „Profesional“ veľkosť 48	988 131 048	<b>189,92 €</b>
	Pracovné nohavice „Profesional“ veľkosť 50	988 131 050	<b>189,36 €</b>
	Pracovné nohavice „Profesional“ veľkosť 52	988 131 052	<b>190,85 €</b>
	Pracovné nohavice „Profesional“ veľkosť 54	988 131 054	<b>189,92 €</b>
	Pracovné nohavice „Profesional“ veľkosť 56	988 131 056	<b>211,91 €</b>
	Pracovné nohavice „Profesional“ veľkosť 58	988 131 058	<b>211,91 €</b>
	Pracovné nohavice „Profesional“ veľkosť 60	988 131 060	<b>231,10 €</b>
	Pracovné nohavice „Profesional“ veľkosť 62	988 131 062	<b>231,10 €</b>
	Pracovné nohavice „Profesional“ veľkosť 98	988 131 098	<b>192,71 €</b>
	Pracovné nohavice „Profesional“ veľkosť 102	988 131 102	<b>211,91 €</b>
Pracovné nohavice „Profesional“ veľkosť 106	988 131 106	<b>211,91 €</b>	
Pracovné nohavice „Profesional“ veľkosť 110	988 131 110	<b>231,10 €</b>	



# pracovní bunda

pracovní bunda „Forest Plus“

		Objednávacie číslo	MOC EUR s DPH
	Pracovní bunda „Forest Plus“ veľkosť 50/52	988 314 852	<b>76,97 €</b>
	Pracovní bunda „Forest Plus“ veľkosť 54/56	988 314 856	<b>76,97 €</b>

		Objednávacie číslo	MOC EUR s DPH
	Pracovní bunda veľkosť 46/48	988 132 048	<b>144,33 €</b>
	Pracovní bunda veľkosť 50/52	988 132 052	<b>144,91 €</b>
	Pracovní bunda veľkosť 54/56	988 132 056	<b>150,01 €</b>
	Pracovní bunda veľkosť 58/60	988 132 060	<b>158,13 €</b>













Promo













# promo







		Objednávacie číslo	MOC EUR s DPH
	Igelitka Dolmar	Werbe004D	0,66 €
	Šiltovka s logom Dolmar	Werbe020D1	6,30 €
	Šiltovka s logom MM4	Werbe020D2	8,95 €
	Zástava Dolmar 120 × 300 cm	995 865 001	68,76 €
	Vlajočky Dolmar (4 m)	995 865 021	16,52 €
	Krabíčka na pílovú reťaz	959 503 106	0,60 €

		Objednávacie číslo	MOC EUR s DPH
	Stojan na píly	995 867 400	<b>232,80 €</b>
	Stojan na krovinořezy <small>*krovinořezy nie sú súčasťou dodávky</small>	12 892	<b>259,09 €</b>
	Stojan na kosačku	712-000276	<b>79,90 €</b>
	Svetelná reklama Dolmar vonkajšia	Werbe	<b>328,95 €</b>
	Flisová bunda Dolmar, Veľkosť: L	R-0006	<b>28,93 €</b>





		Objednávacie číslo	MOC EUR s DPH
	Monterkový komplet č. 54	Werbe252	<b>43,78 €</b>
	Monterkový komplet č. 56	Werbe253	<b>44,87 €</b>
	Monterkový komplet č. 58	Werbe254	<b>38,23 €</b>
	Traky Dolmar	988 048 402	<b>12,15 €</b>
	Tabuľa servis Dolmar 30 × 45 cm	995 932 111	<b>8,82 €</b>
	Pero s logom Dolmar	WERBE058DK	<b>0,97 €</b>
	Obal na lekárničku pre pilčíkov	80-729	<b>10,99 €</b>

		Objednávacie číslo	MOC EUR s DPH
	Taška na potraviny	988 048 409	<b>16,39 €</b>
	Držiak na kriedu, meracie pásmo a iné	988 048 421	<b>5,23 €</b>
	Držiak na klin	988 048 406	<b>10,43 €</b>
	Držiak na fľaše, spreje	988 048 407	<b>10,84 €</b>
	Držiak na fľašu termo	988 048 410	<b>17,78 €</b>

# promo

		Objednávacie číslo	MOC EUR s DPH
	Držiak na mobil vertikálny	988 048 400	<b>8,51 €</b>
	Držiak na mobil horizontálny	988 048 401	<b>6,54 €</b>
	Držiak na lesnícke náradie	988 048 405	<b>27,19 €</b>
	Držiak na sekeru, záhradnícke nožnice, skladaciu pílu	988 048 408	<b>5,51 €</b>
	Držiak na lesnícke náradie s lekárničkou	988 048 422	<b>24,13 €</b>









		Objednávacie číslo	MOC EUR s DPH
	Držiak na lesnícke náradie s lekárničkou	988 048 404	<b>29,72 €</b>
	Kolenačky	988 048 419	<b>16,16 €</b>
	Gélové kolenačky	988 048 420	<b>22,33 €</b>
	Opasok pre držiaky náradia	988 048 411	<b>9,43 €</b>
	Kožený opasok „ťažká váha“	988 048 412	<b>15,01 €</b>

# promo



**DOLMAR**

		Objednávacie číslo	MOC EUR s DPH
	Kožený opasok hnedý M (78–96 cm)	988 048 413	<b>16,20 €</b>
	Kožený opasok hnedý L (94–117 cm)	988 048 414	<b>17,89 €</b>
	Kožený opasok čierny M (78–96 cm)	988 048 416	<b>16,20 €</b>
	Kožený opasok čierny L (94–117 cm)	988 048 417	<b>18,89 €</b>
	Taška pre hobby píly	80-709	<b>33,99 €</b>
	Taška pre farmárske píly	80-721	<b>43,57 €</b>
	Taška pre profesionálne píly	80-732	<b>54,00 €</b>













# Servisné nástroje



# servisné náradie



			Objednávacie číslo	MOC EUR s DPH
	Otáčkomer	Všetky benzínové stroje	950 233 210	<b>237,76 €</b>
	Mierka na nastavenie zapalovania	Všetky benzínové stroje 2 takt	944 500 891	<b>9,59 €</b>
	Vákuová pumpa	Všetky benzínové stroje	956 004 001	<b>306,46 €</b>
	Skrutkovač T 10	Univerzálne	944 500 910	<b>5,99 €</b>
	Skrutkovač T 20	Univerzálne	944 500 840	<b>12,17 €</b>
	Skrutkovač T 25	Univerzálne	944 500 850	<b>13,12 €</b>
	Skrutkovač T 27 Zahnutý	Krovinorezy, motorové píly	940 827 000	<b>2,61 €</b>
	Skrutkovač T 27 (200 mm)	Univerzálne	944 500 862	<b>6,16 €</b>
	Skrutkovač	D Walbro	957 340 030	<b>44,80 €</b>
	Skrutkovač	DD Zama	957 340 020	<b>39,44 €</b>

# servisné náradie



			Objednávacie číslo	MOC EUR s DPH
	Šesťhranný imbusový kľúč s rukoväťou 3 mm (M4)	Univerzálne	940 903 150	<b>3,30 €</b>
	Šesťhranný imbusový kľúč s rukoväťou 4 mm (M5)	Univerzálne	940 904 200	<b>3,39 €</b>
	Šesťhranný imbusový kľúč s rukoväťou 5 mm (M6)	Univerzálne	940 905 200	<b>5,12 €</b>
	Šesťhranný zahnutý imbusový kľúč 5 mm (M6)	Univerzálne	944 500 630	<b>4,06 €</b>
	Kliešte (na vonkajšie poistné krúžky)		946 101 010	<b>61,30 €</b>
	Kliešte (na vnútorné poistné krúžky)		946 101 020	<b>54,28 €</b>
	Vyťahovač	PS-33, 330, 340, 341, 342, 344, 400, 410, 411, 100, 100s, 102, 109, 110i, 110iH, 111, 111i, 115, 112, 113, 114, 116, PS-4600 S, PS-5000,	944 500 871	<b>50,33 €</b>
	Vreteno	PS-33, 330, 340, 341, 342, 344, 400, 410, 411, 100, 100s, 102, 109, 110i, 110iH, 111, 111i, 115, 112, 113, 114, 116, PS-4600 S, PS-5000,	950 203 020	<b>7,37 €</b>
	Pásy na napínanie piestnych krúžkov		944 600 001	<b>23,23 €</b>

# servisné náradie



			Objednávacie číslo	MOC EUR s DPH
	Klin na zablokovanie piesta	MS-340, MS-3300, 3310, MS-4000, 4010, MS-4500, 4510	944 602 001	<b>8,08 €</b>
	Klin na zablokovanie piesta	MS-340, MS-3300, 3310, MS-4000, 4010, MS-4500, 4510	944 602 000	<b>2,49 €</b>
	Tŕň na zablokovanie piesta	MS-340, MS-3300, 3310, MS-4000, 4010, MS-4500, 4510	944 601 030	<b>22,60 €</b>
	Sťahovák 22-1		955 102 015	<b>40,98 €</b>
	Sťahovák veľkosť 3		955 102 020	<b>52,00 €</b>
	Sťahovák veľkosť 2		955 102 025	<b>55,22 €</b>
	Montážny kľúč	PS-34, LT-30, MS-30U, 30C	944 500 695	<b>33,18 €</b>
	Montážny kľúč	PS-33, 330, 340, 341, 342, 344, 400, 401, 410, 411, 100, 100s, 102,109, 110i, 110iH, 111, 111i, ES-30, 35, 140, 160, 1600, 1800,275, 285, 295	944 500 690	<b>31,16 €</b>
	Montážny kľúč	109, 110i, 110iH, 111, 111i, 115, 115i, 115iH, PS-43, 52, 540, PS-6400, 7300, 7900i, PS-6000i, 6800i, 9000, 9010, PC-6212, 6412, 7312, 7314, PC-6212 S, 6412 S, 7312 S, 7314 S	944 500 570	<b>56,05 €</b>
	Montážny kľúč	115i, 115iH	944 603 430	<b>54,02 €</b>
	Montážny kľúč	PS-6000i, 6800i, 112, 113, 114, 116, 116si, 117,119, 120, 120s, 120si.	944 500 680	<b>52,92 €</b>
	Montážny kľúč	PS-3300 TH	944 500 560	<b>52,64 €</b>

# servisné náradie



			Objednávacie číslo	MOC EUR s DPH	
	Montážny kľúč	PS-4600 S, PS-5000	944 500 590	<b>47,54 €</b>	
	Montážny kľúč	103, 105, 108, PS-3410 TH	944 500 940	<b>31,78 €</b>	
	Sada náradia		365 720 330	<b>13,86 €</b>	
	Kliešte	V kombinácii s 944.500.570 a 944.500.590	944 603 400	<b>55,21 €</b>	
	Využitelné v kombinácii s vákuovou pumpou 956.004.001	Tesniaca doska	Tesniaca doska k vákuovej pumpe na PS-33, 330, 340, 341, 342, 344, 400, 401, 410, 411	944 603 010	<b>30,83 €</b>
		Tesniaca doska	Tesniaca doska k vákuovej pumpe na 109, 110i, 110iH, 111, 111i, 115, 115i, 115iH	944 603 020	<b>43,80 €</b>
		Tesniaca doska	Tesniaca doska k vákuovej pumpe na PS-34, PS-6400, 7300, 7900, PC-6212, 6412, 7312, 7314, PC-6212 S, 6412 S, 7312 S, 7314 S	944 603 040	<b>30,11 €</b>
		Tesniaca doska	Tesniaca doska k vákuovej pumpe na PS-4600 S, PS-5000	944 603 170	<b>27,13 €</b>
		Tesniaca doska	Tesniaca doska k vákuovej pumpe na MS-340, MS-3300, 3310, 4000, 4010, 4500, 4510	944 603 130	<b>42,61 €</b>
		Tesniaca doska	Tesniaca doska k vákuovej pumpe na PS-4600 S, PS-5000	944 603 140	<b>28,03 €</b>
	Skúšačka na iskrú sviečky		950 233 230	<b>172,26 €</b>	



# nastavenia píly



Typ	„L“	„H“		min.ot.	max.ot.
<b>LAHKÉ KOMPAKTNÉ PÍLY</b>					
PS-34	3/4 až 1	1		2.800	12.200
PS-33	1	1		2.600	11.500
PS-32 C/TLC	2	4		2.800	12.800
PS-35 C/TLC	1 1/2	2 1/4		2.800	13.100
PS-45-35 (3/8“)	3/4 až 1	1		2.800	12.600
<b>REŤAZOVÉ PÍLY – TRIEDA „FARMÁR“</b>					
PS-350 C/SC-35 (3/8“)	1 1/2	3	!	2.800	13.500
PS-400	1	1		2.600	12.000
PS-401	1	1		2.600	12.000
PS-410	1	1		2.600	12.000
PS-411	1	1		2.600	12.000
PS-420 C/SC-38 (0,325“)	1 1/2	3	!	2.800	13.500
109-38 (3/8“)	1	1		2.500	12.500
109 HS-38 (3/8“)	1	1		2.500	12.500
110i	1	1		2.500	12.500
PS-460-38 (0,325“)	1 1/2	1 1/2		2.500	13.500
PS-460 D-38 (0,325“)	1 1/2	1 1/2		2.500	13.500
PS-460 DX-38 (0,325“)	1 1/2	1 1/2		2.500	13.500
PS-500 /C-38 (3/8“)	1 1/2	1 1/2		2.500	13.500
PS-500 D-38 (3/8“)	1 1/2	1 1/2		2.500	13.500
PS-500 D-38 (0,325“)	1 1/2	1 1/2		2.500	13.500
PS-500 DX-38 (3/8“)	1 1/2	1 1/2		2.500	13.500
111-38 (3/8“)	1	1		2.500	12.500



# nastavenia píí



Typ	„L“	„H“		min.ot.	max.ot.
<b>ŠPECIÁLNE PÍLY</b>					
PS-220 TH-25 (3/8“)	nemá	nemá	len „S“	3.000	11.500
PS-221 TH	nemá	nemá	len „S“	3.000	10.500
PS-3400 TH	1 1/8	1 1/8		3.000	11.500
PS-3410 TH-30 (3/8“)	1 1/8	1 1/8		3.000	12.500
<b>REŤAZOVÉ PÍLY – TRIEDA PROFI</b>					
PS-4600 S-38 (0,325“)	1 1/2	1 1/2		2.500	14.500
PS-4605	1 1/2	1 1/2	!	2.500	14.500
PS-5000-38 (3/8“)	1 1/2	1 1/2		2.500	13.500
PS-5000 D-38 (3/8“)	1 1/2	1 1/2		2.500	13.500
PS-5105 /C	1 1/2	1 1/2	!	2.500	13.500
115-38 (3/8“)	1	1		2.500	13.000
115i	1	1		2.500	13.000
6800 i	1	1		2.400	12.500
PS-6100	1 1/2	2		3.000	13.800
PS-6400-45 (3/8“)	1	1		2.500	13.500
PS-6400 HS-45 (3/8“)	1	1		2.500	13.500
PS-7310	1 1/8	1 3/4		2 500	12 800
PS-7300 HS-45 (3/8“)	1	1		2.500	13.500
PS-7900-45 (3/8“)	1	1		2.500	13.500
PS-7900 HS-45 (3/8“)	1	1		2.500	13.500
PS-7910	1 1/8	1 3/4		2 500	12 800
PS-9010	1	1		2.200	13.500

# balenia olejov



Olej pre dvojtaktné motory 1:50

		kartón/ks	Objednávacie číslo
	100 ml	50	980 008 106
	1 liter	12	980 008 107
	1 liter s odmerkou	12	980 008 112
	5 litrov	4	980 008 118
	60 litrov	1	980 008 270
	200 litrov	1	980 008 151

Olej na mazanie pílových reťazí

		kartón/ks	Objednávacie číslo
	1 liter	12	988 002 256
	5 litrov	4	988 002 258
	60 litrov	1	988 002 265
	200 litrov	1	988 002 261

Olej EXTRA (plne syntetický) pre dvojtaktné motory 1:100

		kartón/ks	Objednávacie číslo
	1 liter	12	980 008 103

Olej na mazanie pílových reťazí (biologický degradovateľný)

		kartón/ks	Objednávacie číslo
	1 liter	12	980 008 210
	5 litrov	4	980 008 211
	10 litrov	2	980 008 212
	20 litrov	1	980 008 213
	60 litrov	1	980 008 265
	200 litrov	1	980 008 218

# balenia olejov

Olej do štvortaktných kosačiek a štvortaktných krovínorezov

		kartón/ks	Objednávacie číslo
	80 ml	10	196122-3
	100 ml	10	197010-7
	600 ml	12	980 008 120
	1 liter (SAE 5 W 30)	12	980 008 121

Multifunkčný olej (na čistenie a ošetrovanie)

		kartón/ks	Objednávacie číslo
	300 ml	12	980 008 301

Prostriedok na čistenie pílových reťazí

		kartón/ks	Objednávacie číslo
	500 ml	12	980 008 125
	5 litrov	4	980 008 126

Olej na ochranu proti korózii

		kartón/ks	Objednávacie číslo
	250 ml	24	980 008 302







Hydraulický olej



		kartón/ks	Objednávacie číslo
	1 liter	12	988 002 500
	5 litrov	4	988 002 510

Olej do vzduchového filtra

		kartón/ks	Objednávacie číslo
	Olej + čistiaci prostriedok.	1	980 008 129



































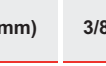
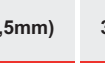
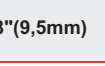

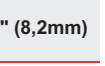

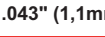

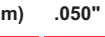



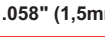



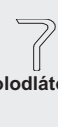
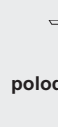



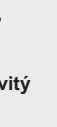













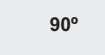
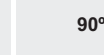
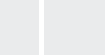

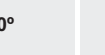
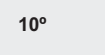

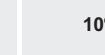
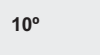







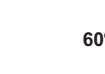

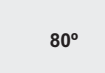

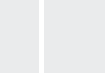
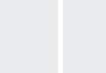
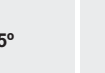
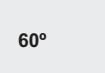
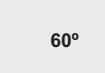
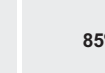
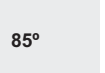



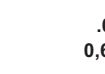

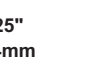

# balenia žacích lánk

	Priemer lanka	Dĺžka lanka	Kartón/ks	Objednávacie číslo
<p>Okrúhle lanko</p>  <p>Okrúhle lanko</p> <p>Okrúhle lanko</p> 	1,3 mm	15 m	240	369 224 807
	1,6 mm	15 m	240	369 224 808
	2,0 mm	15 m	187	369 224 790
	2,0 mm	126 m	36	369 224 791
	2,4 mm	15 m	187	369 224 792
	2,4 mm	87 m	36	369 224 793
	2,4 mm	262 m	8	369 224 794
	3,0 mm	15 m	187	369 224 809
	3,0 mm	56 m	36	369 224 811
	3,0 mm	168 m	8	369 224 815
<p>Okrúhle lanko +</p>  	3,3 mm	15 m	187	369 224 810
	3,3 mm	46 m	36	369 224 812
	3,3 mm	139 m	8	369 224 816
	3,5 mm	41 m	36	369 224 813
	3,5 mm	123 m	8	369 224 817
	4,0 mm	30 m	36	369 224 814
	4,0 mm	90 m	8	369 224 818
	2,4 mm	15 m	119	369 224 795
<p>Hranaté lanko +</p>  	2,4 mm	69 m	36	369 224 796
	2,4 mm	206 m	8	369 224 797

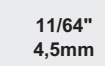
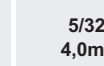
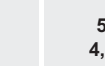
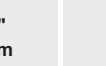
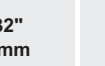
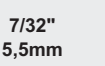
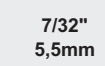
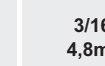
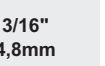
	Priemer lanka	Dĺžka lanka	Kartón/ks	Objednávacie číslo
 <p>Hranaté lanko +</p>	3,0 mm	15 m	187	369 224 819
	3,0 mm	44 m	36	369 224 821
	3,0 mm	132 m	8	369 224 825
	3,3 mm	15 m	187	369 224 820
	3,3 mm	36 m	36	369 224 822
	3,3 mm	109 m	8	369 224 826
	3,5 mm	32 m	36	369 224 823
	3,5 mm	96 m	8	369 224 827
	4,0 mm	25 m	36	369 224 824
	4,0 mm	75 m	8	369 224 828
 <p>Okrúhle lanko Pro</p>	3,0 mm	15 m	119	369 224 798
	3,0 mm	56 m	36	369 224 799
	3,0 mm	168 m	8	369 224 800
	3,0 mm	279 m	8	369 224 801
 <p>Hranaté lanko Pro</p>	3,0 mm	15 m	102	369 224 802
	3,0 mm	44 m	36	369 224 803
	3,0 mm	132 m	8	369 224 804
	3,0 mm	219 m	8	369 224 805

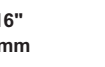
# typy reťazí

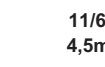

										
Typ reťaze	<b>290</b>	<b>092</b>	<b>480</b>	<b>093</b>	<b>099</b>	<b>696</b>	<b>484</b>	<b>086</b>	<b>686</b>	<b>466</b>
Zariadenie na redukovanie spätného nárazu										
Delenie reťaze	 3/8"(9,5mm)	 3/8"(9,5mm)	 3/8"(9,5mm)	 3/8"(9,5mm)	 3/8"(9,5mm)	 3/8"(9,5mm)	 .325" (8,2mm)	 .325" (8,2mm)	 .325" (8,2mm)	 1/4"(6,3mm)
Výška zuba	 .043" (1,1mm)	 .050" (1,3mm)	 .050" (1,3mm)	 .058" (1,5mm)	 .058" (1,5mm)	 .058" (1,5mm)	 .050" (1,3mm)	 .058" (1,5mm)	 .058" (1,5mm)	 .050"(1,3mm)
Tvar hobľovacieho zuba	 polodlátovitý	 polodlátovitý	 polodlátovitý	 polodlátovitý	 dlátovitý	 dlátovitý	 polodlátovitý	 polodlátovitý	 dlátovitý	 polodlátovitý
Uhol brúsenia hornej platničky	 30°	 30°	 30°	 35°	 25°	 25°	 30°	 30°	 25°	 30°
Uhol vedenia pilníka	 90°	 90°	 90°	 90°	 10°	 10°	 10°	 10°	 10°	 10°
Rezací uhol hornej platničky	 50°	 60°	 60°	 60°	 60°	 60°	 60°	 60°	 60°	 60°
Uhol postrannej platničky	 80°	 80°	 80°	 85°	 60°	 60°	 85°	 85°	 60°	 85°
Nastavenie hĺbky zuba	 .025" 0,64mm	 .025" 0,64mm	 .025" 0,64mm	 .025" 0,64mm	 .025" 0,64mm	 .025" 0,64mm	 .025" 0,64mm	 .025" 0,64mm	 .025" 0,64mm	 .025" 0,64mm
Guľatý pilník v prvej polovici	 11/64" 4,5mm	 5/32" 4,0mm	 5/32" 4,0mm	 7/32" 5,5mm	 7/32" 5,5mm	 7/32" 5,5mm	 3/16" 4,8mm	 3/16" 4,8mm	 3/16" 4,8mm	 5/32" 4,0mm
Guľatý pilník neskôr	-	-	-	 3/16" 4,8mm	 3/16" 4,8mm	 3/16" 4,8mm	 11/64" 4,5mm	 11/64" 4,5mm	 11/64" 4,5mm	 5/32" 4,0mm





# Regálové vybavenie predajní



# regále



Regál DD1



Regál DD2



Regál DD3



Regál DK1



Regál DP1



Regál DP2



# regále



Regál DP3



Regál DP4



Regál DP5



Rohový regál 45° DR1

# regál pre motorové píly

DD1

Popis	Počet (ks)	Materiál
S01 – panel zadný hladký 1000 × 400 mm	5	M01
S03 – polica plechová 1000 × 500 mm, bez držiaku	2	M01
S04 – polica plechová 1000 × 700 mm, bez držiaku	1	M01
S05 – sokel – panel zadný hladký 1000 × 100 mm	1	M01
S06 – noha SU5 hl=700 mm	2	M01
S07 – stojka 80/30, v=2200 mm, vr. podpery stojky a rekt. skrutky M10	2	M01
S08 – konzola hl=500 mm	4	M01
P01A – zastrešenie vrátane žiarivky OPPLÉ FISB 873, 21W M1000(P02+P03)	1	M01
P18 – logo Dolmar 500 × 35 × 250 mm + samolepka Dolmar 510 × 265 mm – voliteľné	1	M01

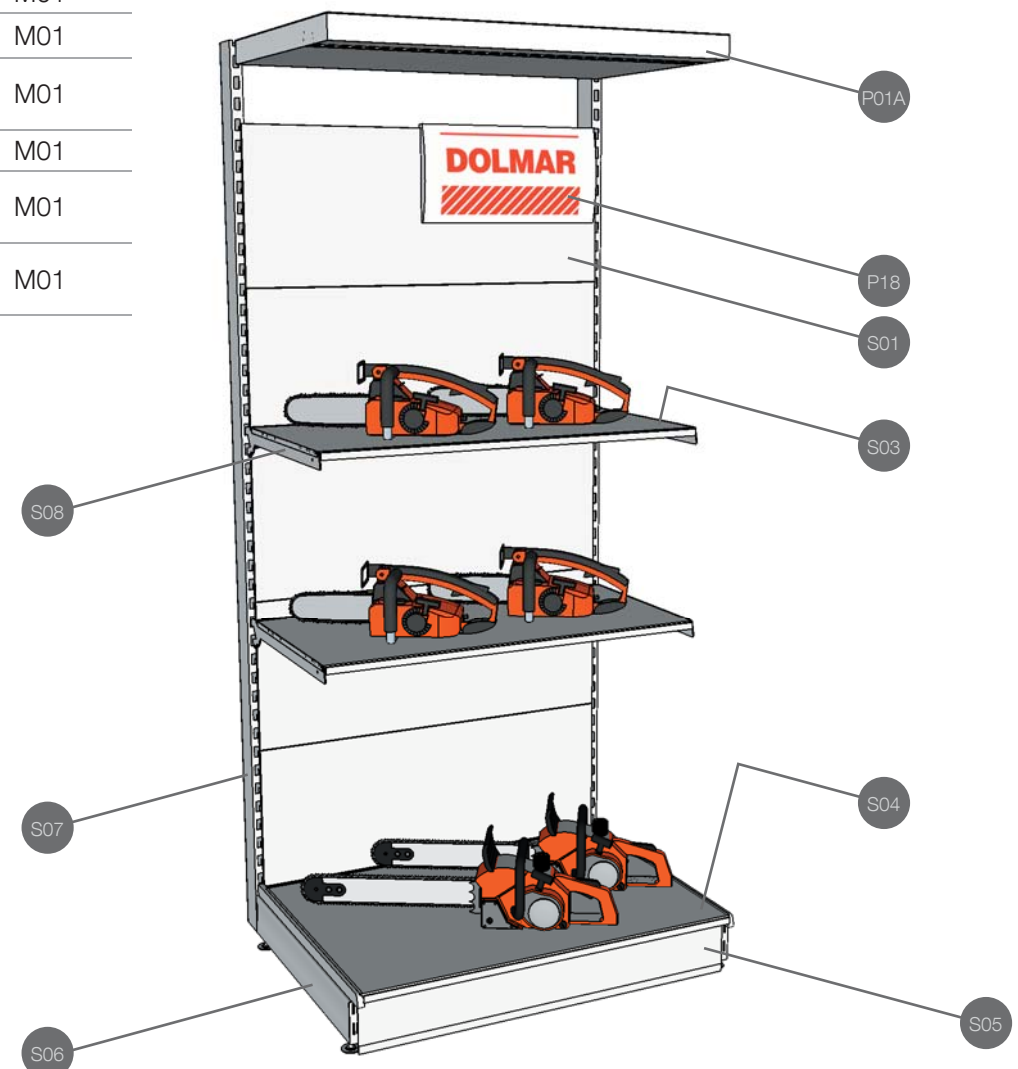

Netto cena bez DPH pre predajcov DOLMAR: 78,00 €  
Cena bez DPH: 155,58 €



DD1 S01



DD1 S01A



DD1 S01B



DD1 S01 Action



DD1 S01A Action



DD1 S01B Action

# regál pre motorové píly

DD2

Popis	Počet (ks)	Materiál
S01 – panel zadný hladký 1000 × 400 mm	5	M01
S03 – polica plechová 1000 × 500 mm, bez držiaku	3	M01
S04 – polica plechová 1000 × 700 mm, bez držiaku (polica 500 + polica 200)	1	M01
S05 – sokel – panel zadný hladký 1000 × 100 mm	1	M01
S06 – noha SU5 hl=700 mm	2	M01
S07 – stojky 80/30, v=2200 mm, vr. podpery stojky a rekt. skrutky M10	2	M01
S08 – konzola hl=500 mm	6	M01
P01A – zastrešenie vrátane žiarivky OPPLÉ FISB 873, 21 W modul 1000	1	M01
P18 – logo Dolmar 500 × 35 × 250 mm + samolepka Dolmar 510 × 265 mm – voliteľné	1	M01

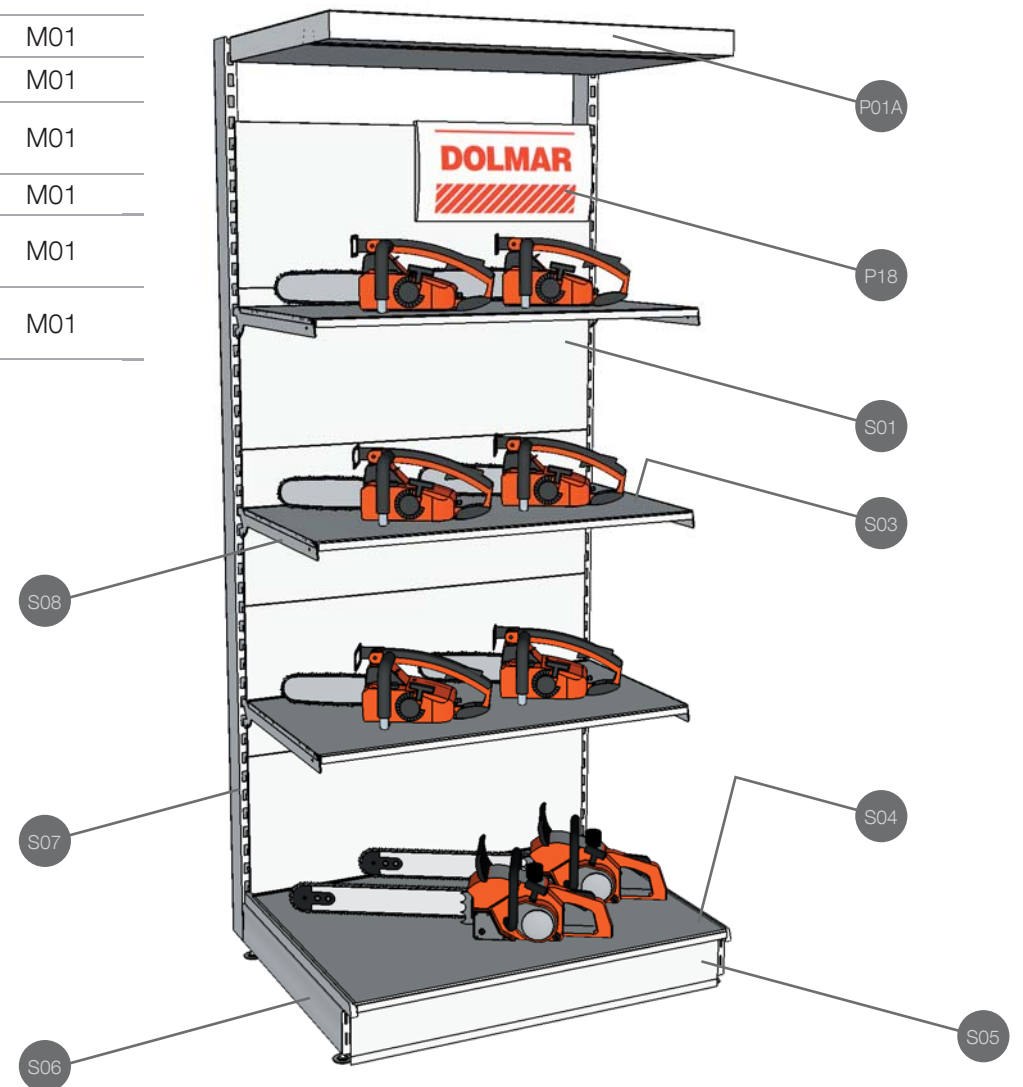

Netto cena bez DPH pre predajcov DOLMAR: 106,00 €  
Cena bez DPH: 210,62 €





DD2 S01



DD2 S01A



DD2 S01B



DD2 S01 Action



DD2 S01A Action1



DD2 S01A Action2



DD2 S01B Action

# regál pre motorové píly

DD3

Popis	Počet (ks)	Materiál
S01 – panel zadný hladký 1000 × 400 mm	5	M01
S03 – polica plechová 1000 × 500 mm, bez držiaku	1	M01
S04 – polica plechová 1000 × 700 mm, bez držiaku (polica 500 + polica 200)	1	M01
S05 – sokel – panel zadný hladký 1000 × 100 mm	1	M01
S06 – noha SU5 hl=700 mm	2	M01
S07 – stojka 80/30, v=2200 mm, vr. podpery stojky a rekt. skrutky M10	2	M01
S08 – konzola hl=500 mm	2	M01
P01A – zastrešenie vrátane žiarivky OPPLÉ FISB 873, 21 W modul 1000	1	M01
P03 – traverza na držiaky krovinorezov a reťazových píl 1000 × 60 × 110mm	2	M01
P04 – držiak na reťazové píly 500 × 500 × 400mm	4	M01
P18 – logo Dolmar 500 × 35 × 250 mm + samolepka Dolmar 510 × 265 mm – voliteľné	1	M01

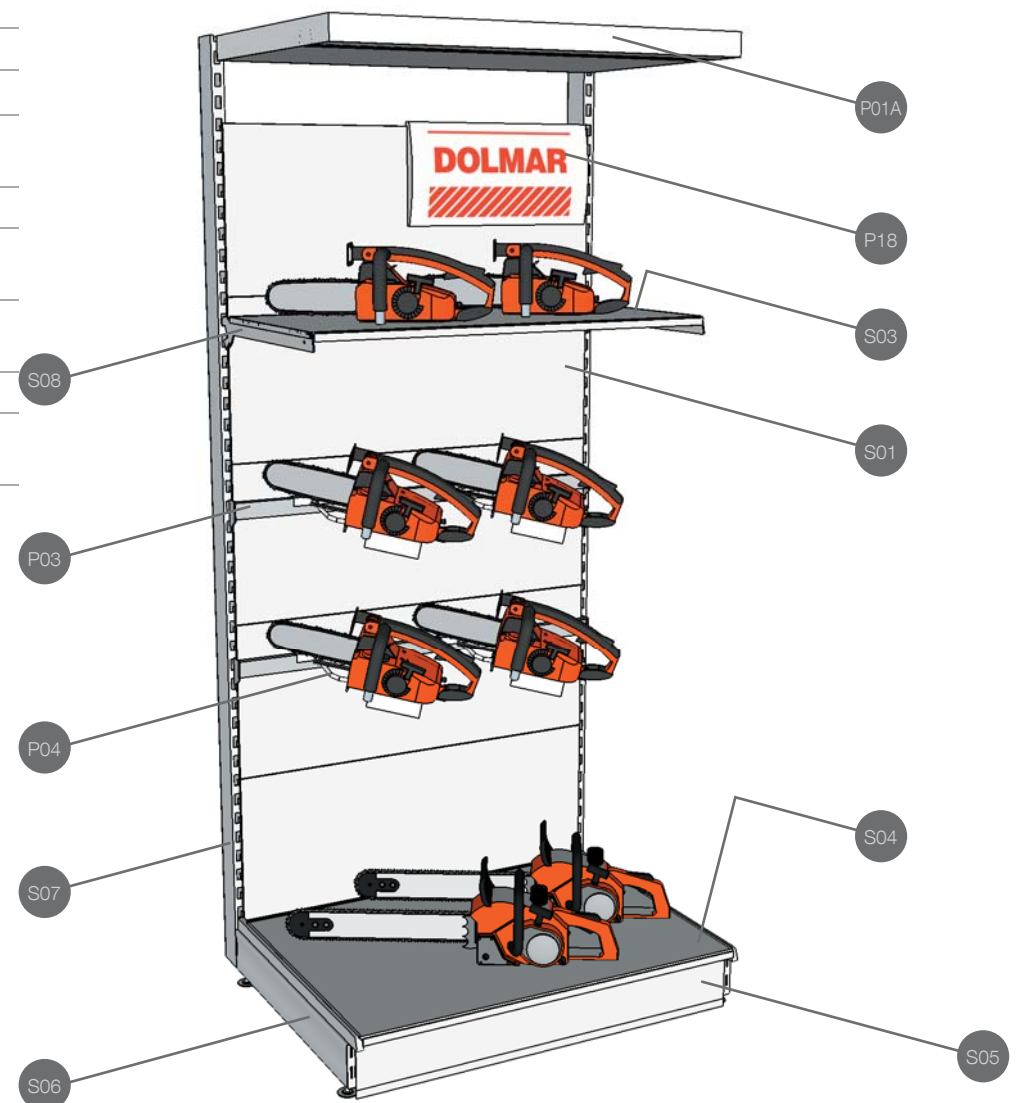

Netto cena bez DPH pre predajcov DOLMAR: 104,00 €  
Cena bez DPH: 207,87 €



DD3 S01



DD3 S01B



DD3 S01 Action



DD3 S01B Action1



DD3 S01B Action2

# regál pre krovinorezy

DK1

Popis	Počet (ks)	Materiál
S01 – panel zadný hladký 1000 × 400 mm	2	M01
S02 – panel zadný dierovaný 1000 × 400 mm	3	M01
S04 – polica plechová 1000 × 700 mm, bez držiaku (polica 500 + polica 200)	1	M01
S05 – sokel – panel zadný hladký 1000 × 100 mm	1	M01
S06 – noha SU5 hl=700 mm	2	M01
S07 – stojka 80/30, v=2200 mm, vr. podpery stojky a rekt. skrutky M10	2	M01
P01A – zastrešenie vrátane žiarivky OPPLÉ FISB 873, 21 W modul 1000	1	M01
P08 – traverza na držiaky krovinorezov a reťazových píl 1000 × 60 × 110mm	1	M01
P09 – držiak na krovinorez 126 × 470 × 120mm	3	M01
P10 – držiak 66 × 290 × 61mm do dierovaných zadných panelov	3	M01
P18 – logo Dolmar 500 × 35 × 250 mm + samolepka Dolmar 510 × 265 mm – voliteľné	1	M01

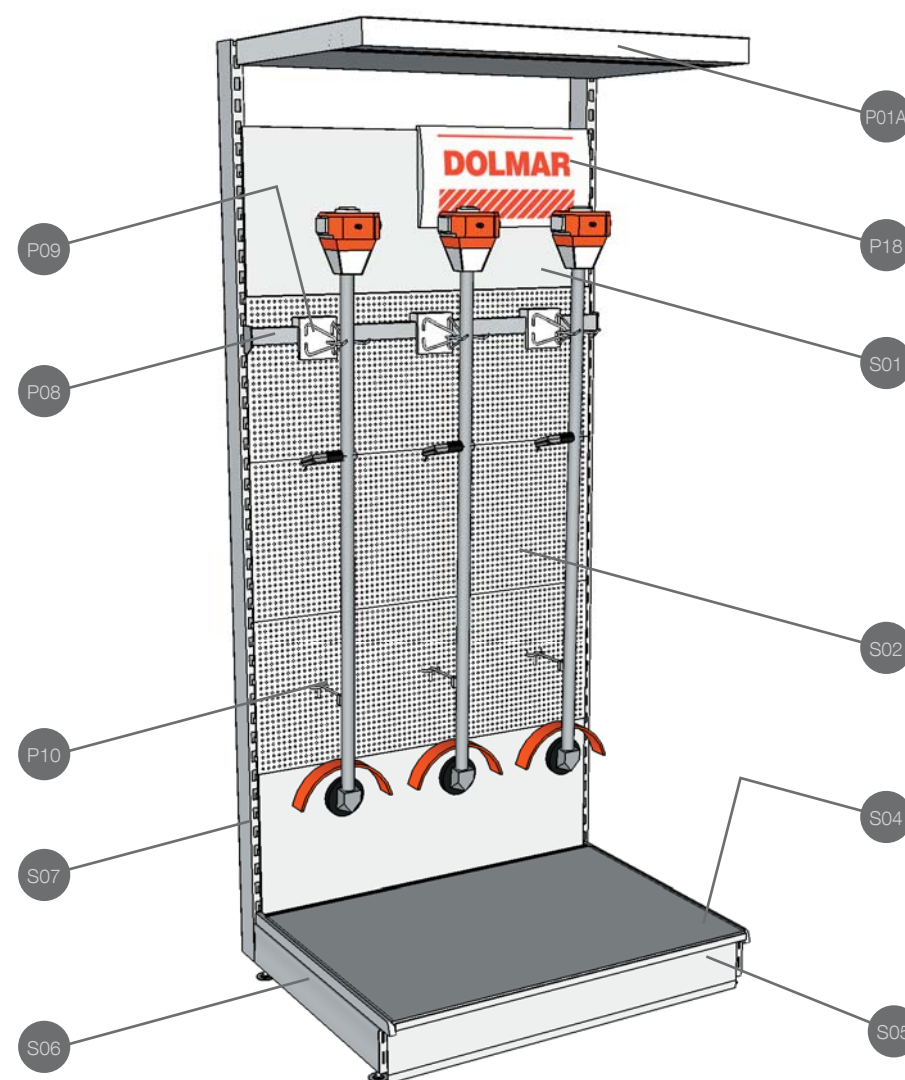

Netto cena bez DPH pre predajcov DOLMAR: 98,00 €  
Cena bez DPH: 194,89 €



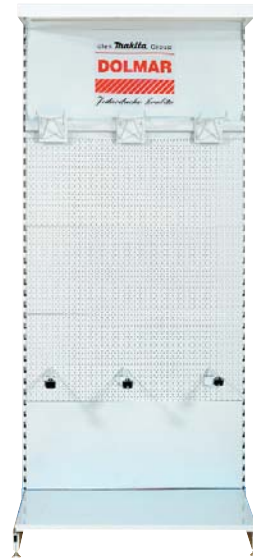

DK1 S01

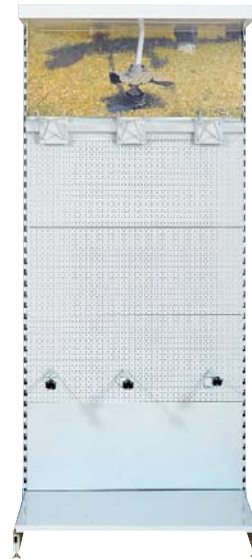

DK1 S01C



DK1 S01 Action



DK1 S01C Action

# regál pre príslušenstvo

DP1

Popis	Počet (ks)	Materiál
S01 – panel zadný hladký 1000 × 400 mm	1	M01
S02 – panel zadný dierovaný 1000 × 400 mm	4	M01
S04 – polica plechová 1000 × 700 mm, bez držiaku	1	M01
S05 – sokel – panel zadný hladký 1000 × 100 mm	1	M01
S06 – noha SU5 hl=700 mm	2	M01
S07 – stojka 80/30, v=2200 mm, vr. podpery stojky a rekt. skrutky M10	2	M01
S08 – konzola hl=500 mm	1	M01
P01A – zastrešenie vrátane žiarivky OPPLÉ FISB 873, 21W M1000(P02+P03)	1	M01
P07 – háčik dvojité L200 / L250 do dierovaných zadných panelov	2	M01
P14/P15 – držiak sekier malý/veľký 70/90 × 257 × 250 mm do dierovaných zadných panelov	6	M01
P18 – logo Dolmar 500 × 35 × 250 mm + samolepka Dolmar 510 × 265 mm – voliteľné	1	M01
P24 – držiak nožníc na konáre 130 × 170 × 110 mm	2	M01

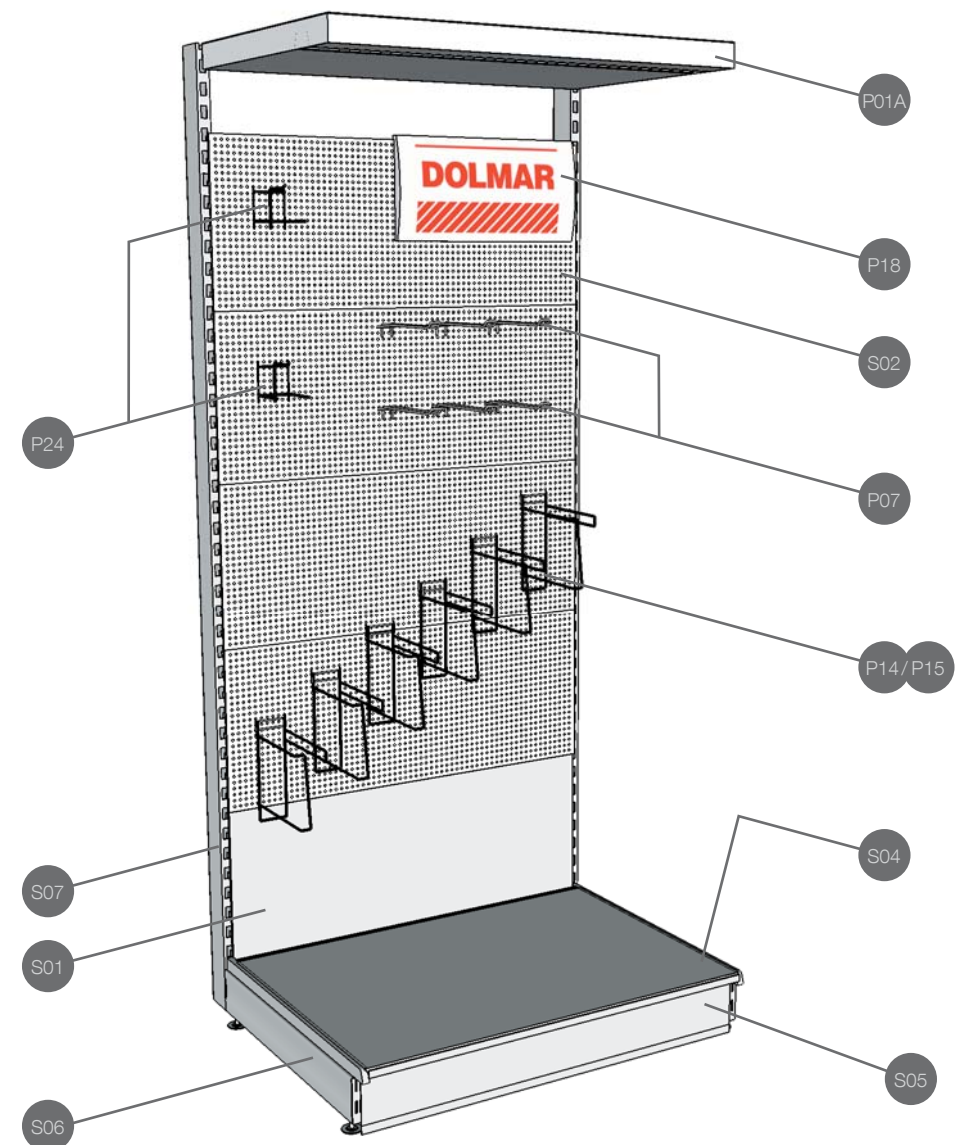

Netto cena bez DPH pre predajcov DOLMAR: 178,00 €

Cena bez DPH: 296,07 €



DP1 S01

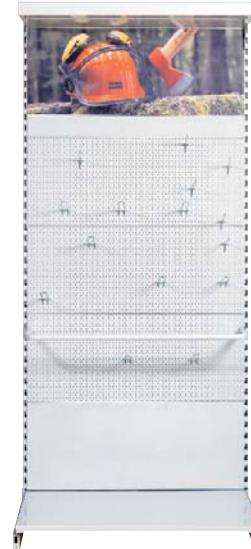

DP1 S01A



DP1 S01 Action



DP1 S01A Action

# regál pre príslušenstvo

DP2

Popis	Počet (ks)	Materiál
S01 – panel zadný hladký 1000 × 400 mm	2	M01
S02 – panel zadný dierovaný 1000 × 400 mm	3	M01
S04 – polica plechová 1000 × 700 mm, bez držiaku	1	M01
S05 – sokel – panel zadný hladký 1000 × 100 mm	1	M01
S06 – noha SU5 hl=700 mm	2	M01
S07 – stojky 80/30, v=2200 mm, vr. podpery stojky a rekt. skrutky M10	2	M01
S08 – konzola hl=500 mm	1	M01
P01A – zastrešenie vrátane žiarivky OPPLÉ FISB 873, 21W M1000(P02+P03)	1	M01
P06 – háčik jednoduchý L200 / L250 do dierovaných zadných panelov	10	M01
P07 – háčik dvojité L200 / L250 do dierovaných zadných panelov	5	M01
P18 – logo Dolmar 500 × 35 × 250 mm + samolepka Dolmar 510 × 265 mm – voliteľné	1	M01

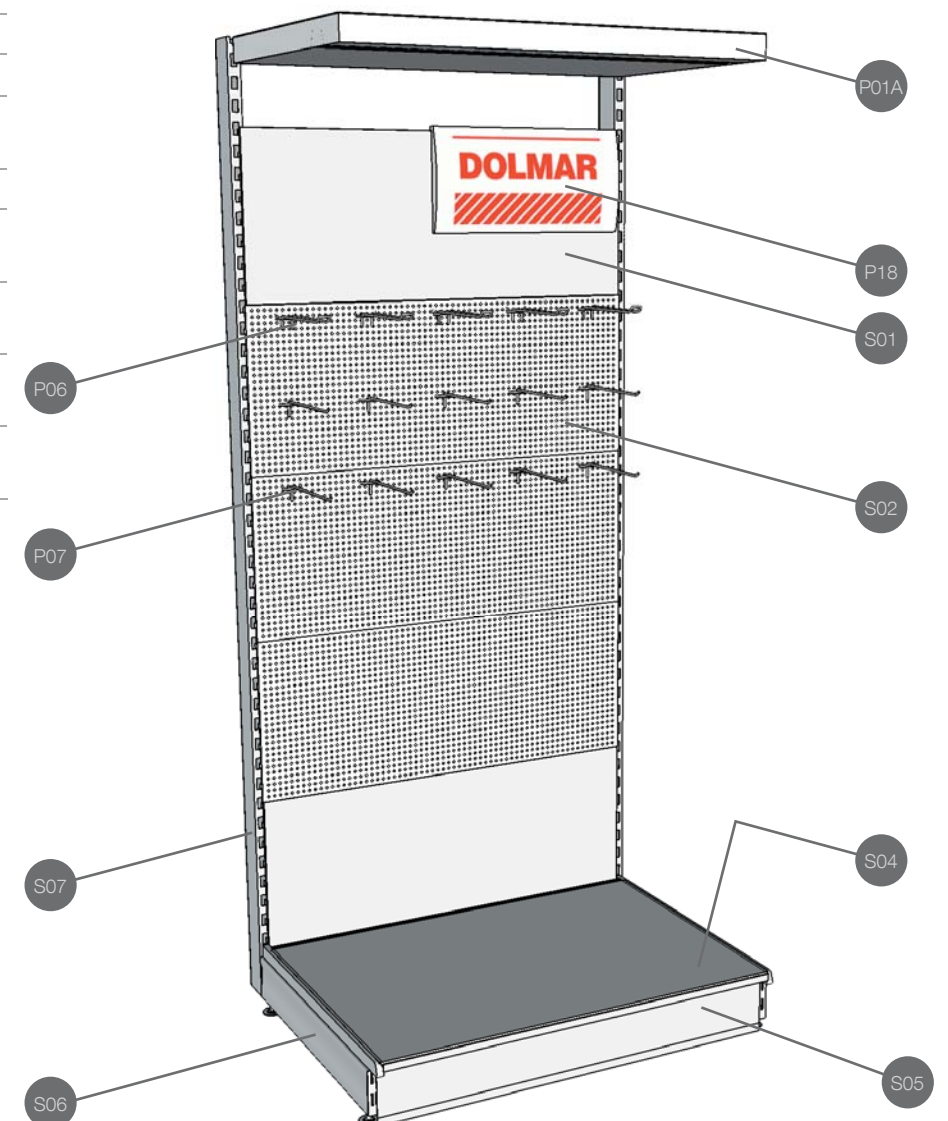

Netto cena bez DPH pre predajcov DOLMAR: 153,00 €

Cena bez DPH: 304,20 €



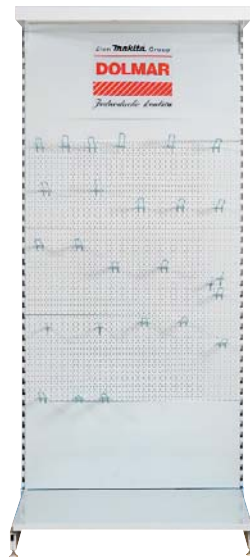

DP2 S01

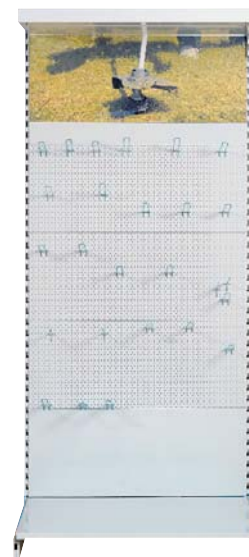

DP2 S01C



DP2 S01 Action



DP2 S01C Action

# regál pre príslušenstvo

DP4

Popis	Počet (ks)	Materiál
S01 – panel zadný hladký 1000 × 400 mm	2	M01
S02 – panel zadný dierovaný 1000 × 400 mm	3	M01
S04 – polica plechová 1000 × 700 mm, bez držiaku	1	M01
S05 – sokel – panel zadný hladký 1000 × 100 mm	1	M01
S06 – noha SU5 hl=700 mm	2	M01
S07 – stojka 80/30, v=2200 mm, vr. podpery stojky a rekt. skrutky M10	2	M01
S08 – konzola hl=500 mm	1	M01
P01A – zastrešenie vrátane žiarivky OPPLÉ FISB 873, 21W M1000(P02+P03)	1	M01
P07 – háčik dvojité L200 / L250 do dierovaných zadných panelov	6	M01
P14/P15 – držiak sekier malý/velký 70/90 × 257 × 250 mm do dierovaných zadných panelov	6	M01
P18 – logo Dolmar 500 × 35 × 250 mm + samolepka Dolmar 510 × 265 mm – voliteľné	1	M01
P21 – gumová podložka 1000 × 700 × 4 mm 1 M01	1	M01
P22 – polica rámová 1000 × 400 mm s drôteným rastrom	2	M01

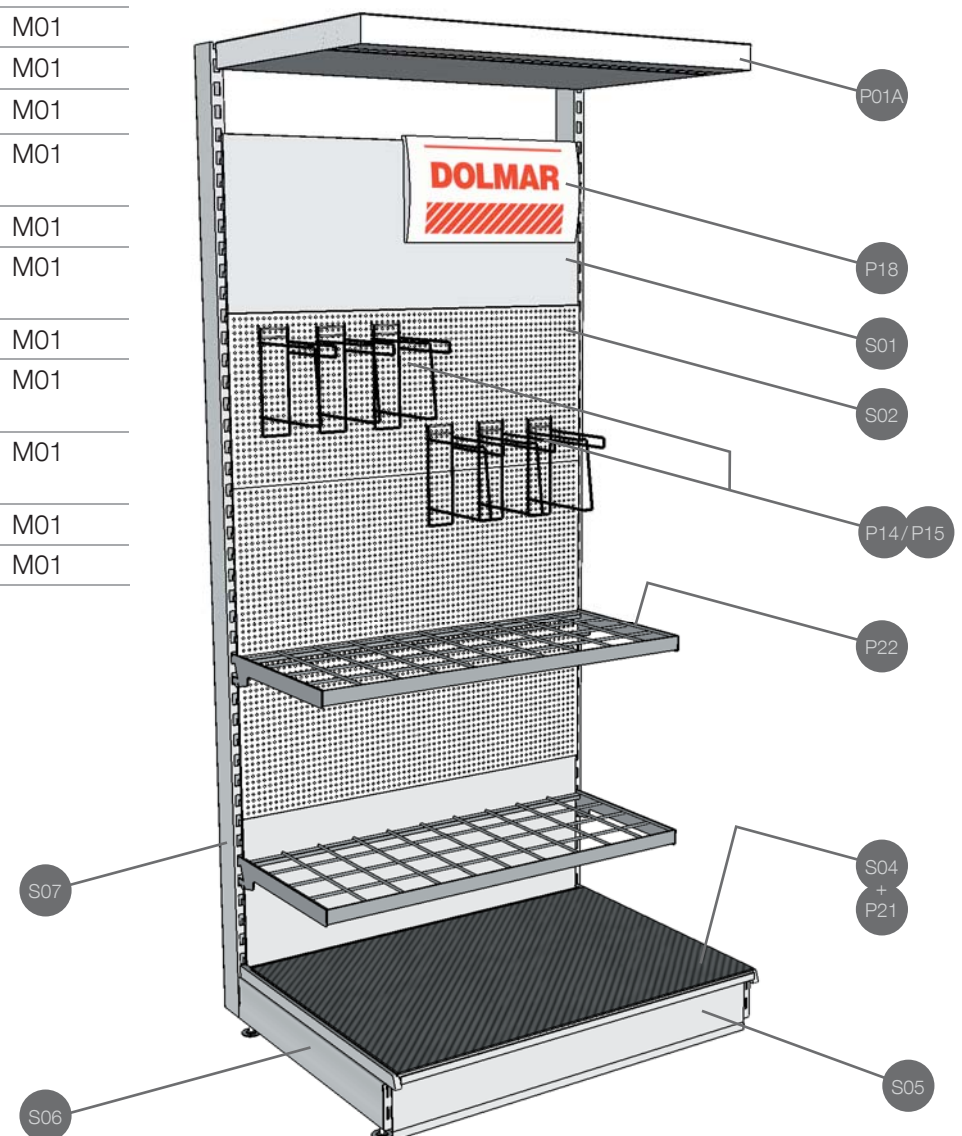

Netto cena bez DPH pre predajcov DOLMAR: 102,00 €  
Cena bez DPH: 169,30 €



DP4 S01



DP4 S01A



DP4 S01A Action

# regál pre príslušenstvo

DP5

Popis	Počet (ks)	Materiál
S01 – panel zadný hladký 1000 × 400 mm	2	M01
S02 – panel zadný dierovaný 1000 × 400 mm	3	M01
S03 – polica plechová 1000 × 500 mm, bez držiaku	2	M01
S04 – polica plechová 1000 × 700 mm, bez držiaku (polica 500 + polica 200)	1	M01
S05 – sokel – panel zadný hladký 1000 × 100 mm	1	M01
S06 – noha SU5 hl=700 mm	2	M01
S07 – stojka 80/30, v=2200 mm, vr. podpery stojky a rekt. skrutky M10	2	M01
S08 – konzola hl=500 mm	1	M01
P01 – zastrešenie vrátane žiarivky OPPLÉ FISB 873, 21 W modul 1000	1	M01
P05 – polica pre drobný tovar 1000 × 500 × 100mm (18 ks boxov)	1	M01
P06 – háčik jednoduchý L200 / L250 do dierovaných zadných panelov	10	M01
P07 – háčik dvojitý L200 / L250 do dierovaných zadných panelov	5	M01
P18 – logo Dolmar 500 × 35 × 250 mm + samolepka Dolmar 510 × 265 mm – voliteľné	1	M01

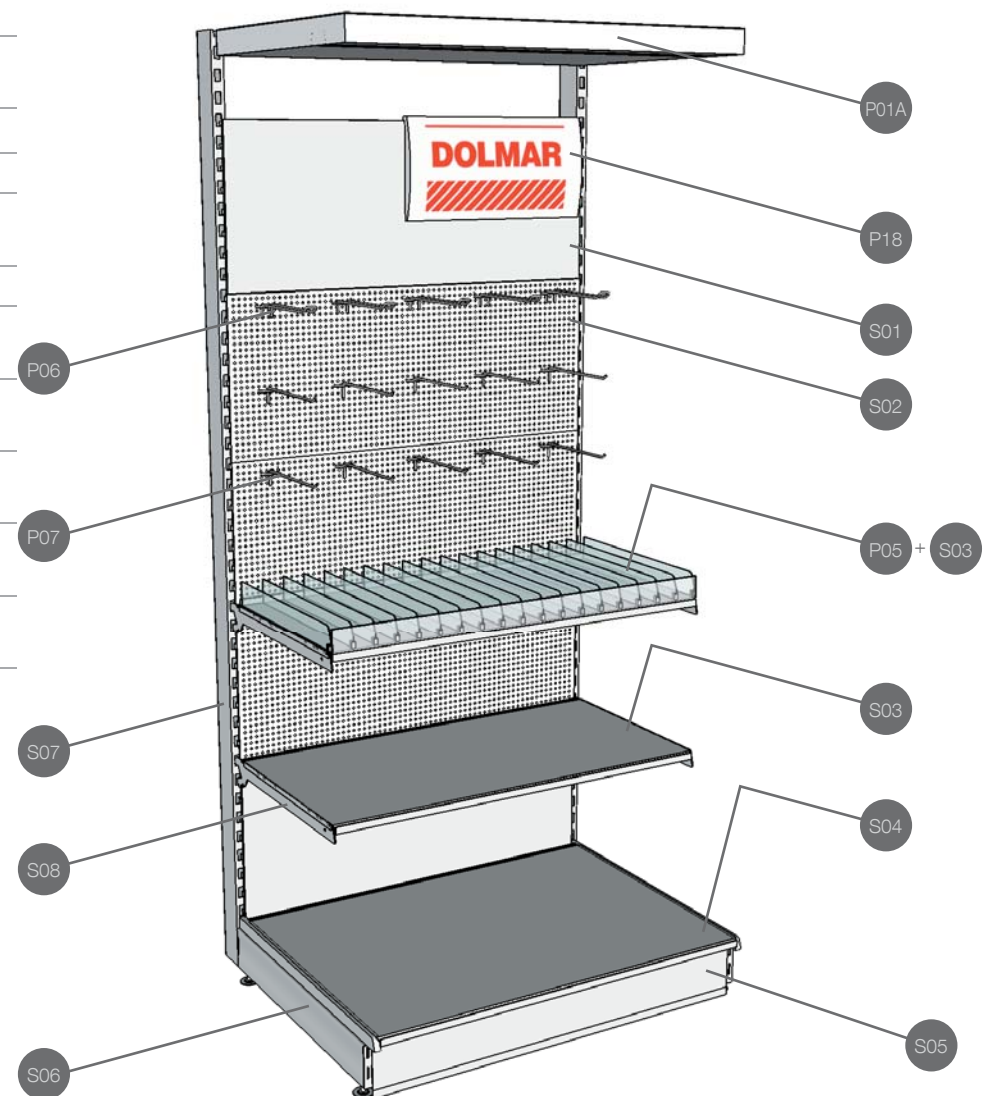

Netto cena bez DPH pre predajcov DOLMAR: 137,00 €  
Cena bez DPH: 273,54 €



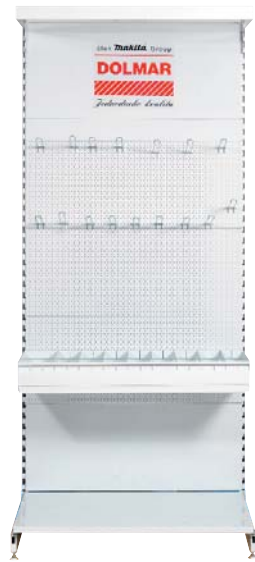

DP5 S01

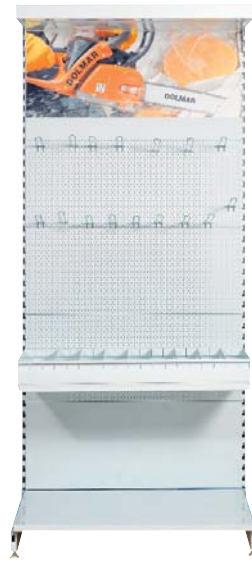

DP5 S01B



DP5 S01 Action



DP5 S01B Action

# regál pre oblečenie

DP3

Popis	Počet (ks)	Materiál
S01 – panel zadný hladký 1000 × 400 mm	5	M01
S04 – polica plechová 1000 × 700 mm, bez držiaču (polica 500 + polica 200)	1	M01
S05 – sokel – panel zadný hladký 1000 × 100 mm	1	M01
S06 – noha SU5 hl=700 mm	2	M01
S07 – stojka 80/30, v=2200 mm, vr. podpery stojky a rekt. skrutky M10	2	M01
P01A – zastrešenie vrátane žiarivky OPPLÉ FISB 873, 21 W modul 1000	1	M01
P11 – rám na oblečenie 1000 × 350mm s háčikmi do stojok	1	M01
P18 – logo Dolmar 500 × 35 × 250 mm + samolepka Dolmar 510 × 265 mm – voliteľné	1	M01

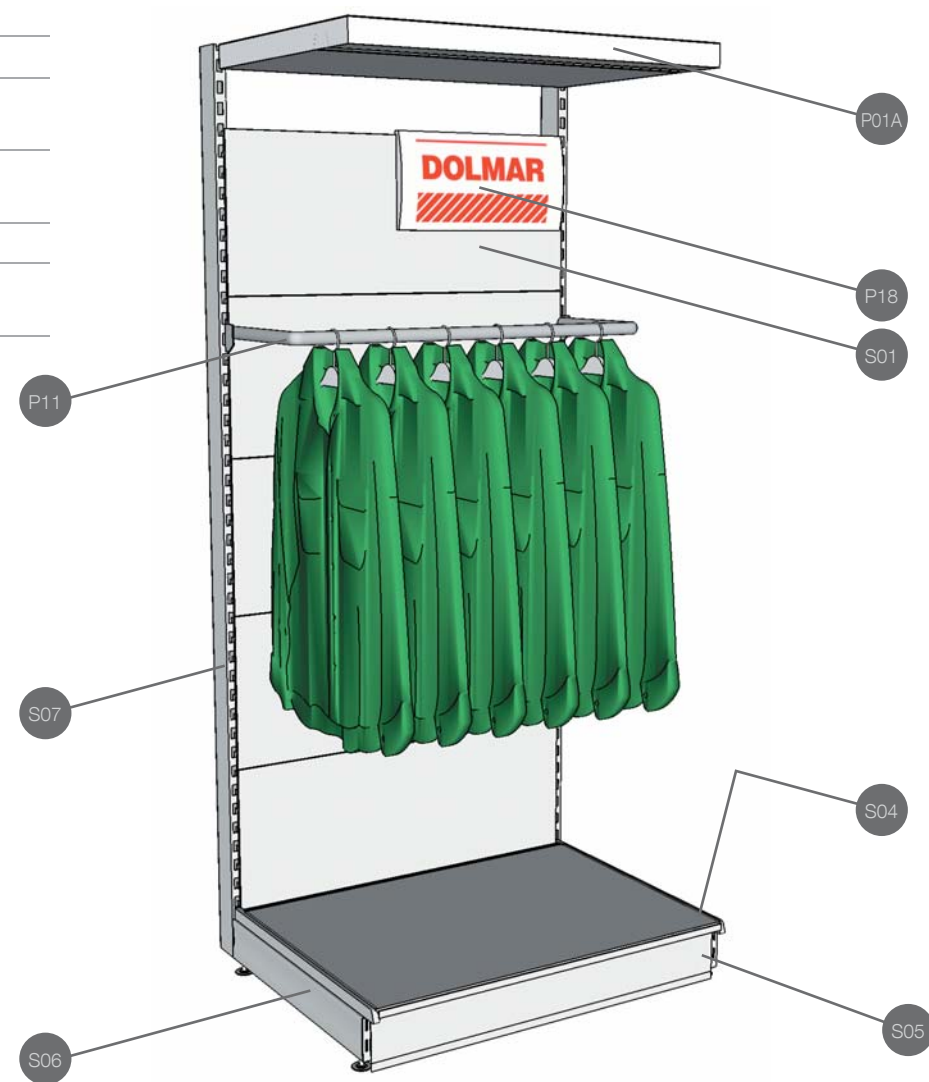

Netto cena bez DPH pre predajcov DOLMAR: 150,00 €  
Cena bez DPH: 212,91 €



DP3 S01



DP3 S01 Action

# rohový regál 45°

DR1

Popis	Počet (ks)	Materiál
S05 – sokel – panel zadný hladký 1000 × 100 mm	2	M01
S06 – noha SU5 hl=700 mm	2	M01
S07 – stojka 80/30, v=2200 mm, vr. podpery stojky a rekt. skrutky M10	3	M01
S08 – konzola hl=500 mm	6	M01
S09 – panel zadný hladký 1000 × 400 mm ľavý	2	M01
S10 – panel zadný hladký 1000 × 400 mm pravý	2	M01
S11 – panel zadný dierovaný 1000 × 400 mm ľavý	3	M01
S12 – panel zadný dierovaný 1000 × 400 mm pravý	3	M01
S13 – polica plechová 1000 × 500 mm ľavá, bez držiaku	3	M01
S14 – polica plechová 1000 × 500 mm pravá, bez držiaku	3	M01
S15 – polica plechová 1000 × 700 mm ľavá, bez držiaku	1	M01
S16 – polica plechová 1000 × 700 mm pravá, bez držiaku	1	M01
S17 – noha SU5 hl=900 mm	1	M01
S18 – konzola vysoká kútová 735 mm	4	M01
S19 – sokel – panel zadný hladký kútový – pravý v=100 mm	1	M01
S20 – sokel – panel zadný hladký kútový – ľavý v=100 mm	1	M01
P02 – zastrešenie (ľavá strana), bez žiarivky	1	M01
P12 – zastrešenie (pravá a ľavá strana), bez žiarivky	1+1	M01
P18 – logo Dolmar 500 × 35 × 250 mm + samolepka Dolmar 510 × 265 mm – voliteľné	1	M01

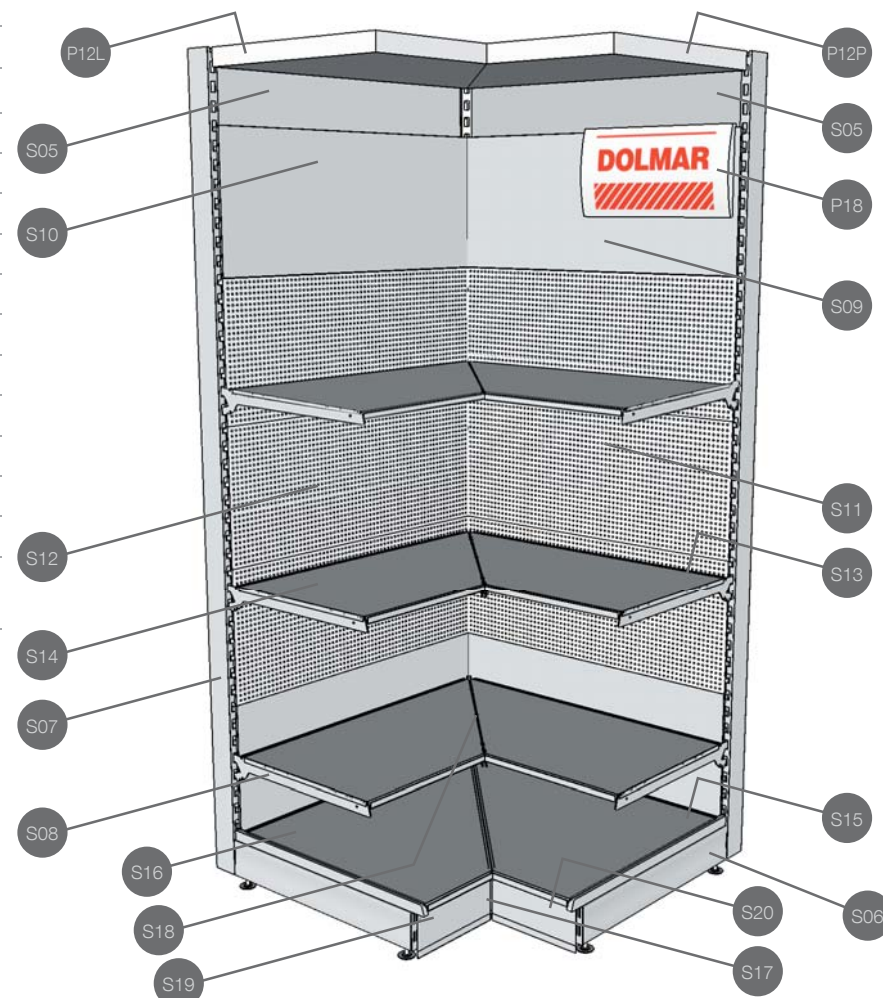

Netto cena bez DPH pre predajcov DOLMAR: 268,00 €  
Cena bez DPH: 535,30 €



DR1 S01



DR1 S01 Action



# priestorové regále



Priestorový regál DS1



Priestorový regál DS2





Priestorový regál DS3



# priestorový regál

DS1

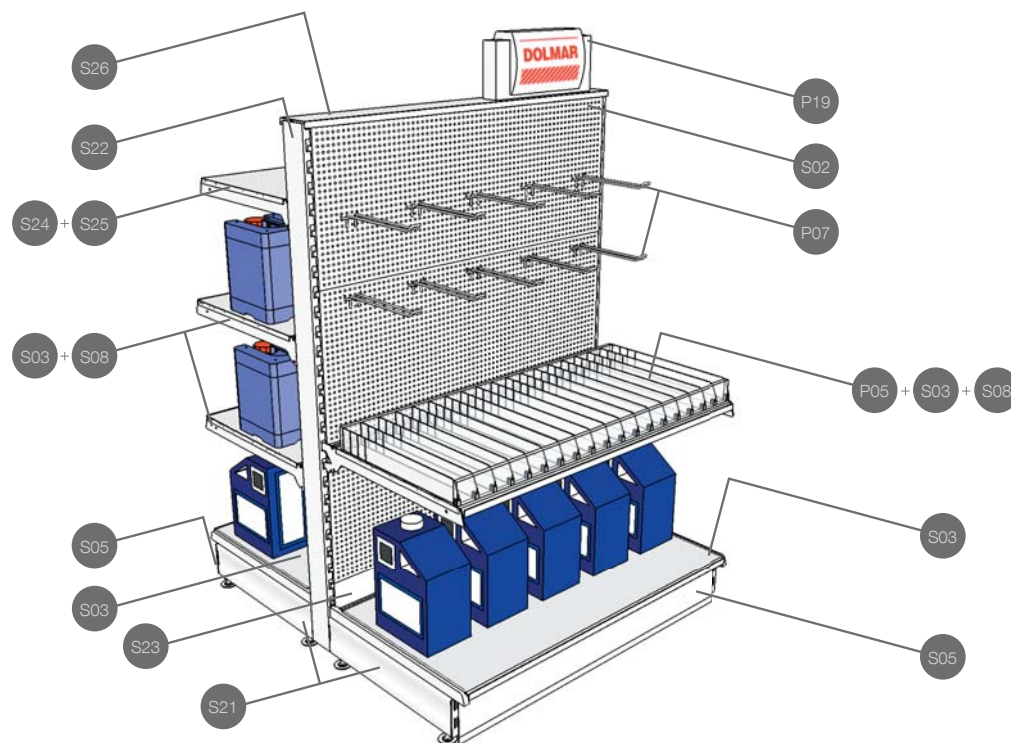

Popis	Počet (ks)	Materiál
S02 – panel zadný dierovaný 1000 × 400 mm	6	M01
S03 – police plechová 1000 × 500 mm, bez držiaku	5	M01
S05 – sokel – panel zadný hladký 1000 × 100 mm	2	M01
S21 – noha SU5 hl=500 mm	4	M01
S22 – stojina 80/30, v=1408 mm, vr. podpery stojky a rekt. skrutky M10	2	M01
S23 – panel zadný hladký 1000 × 100 mm	2	M01
S24 – police plechová 1000 × 400 mm, bez držiaku	1	M01
S25 – konzola vysoká 400 mm	1	M01
S26 – plechový kryt gondoly pro modul 1000 mm	1	M01
P05 – schránka pre drobný tovar 1000 × 500 × 100mm (18 ks boxov)	1	M01
P07 – háčik dvojitý L200 / L250 do dierovaných zadných panelov	1	M01
P19 – Logo Dolmar 360 × 100 × 170 mm+samolepka Dolmar 270 × 180 mm – voliteľné	1	M01



Priestorový regál DS1

Netto cena bez DPH pre predajcov DOLMAR: 215,00 €  
Cena bez DPH: 267,91 €

# priestorový regál

DS2

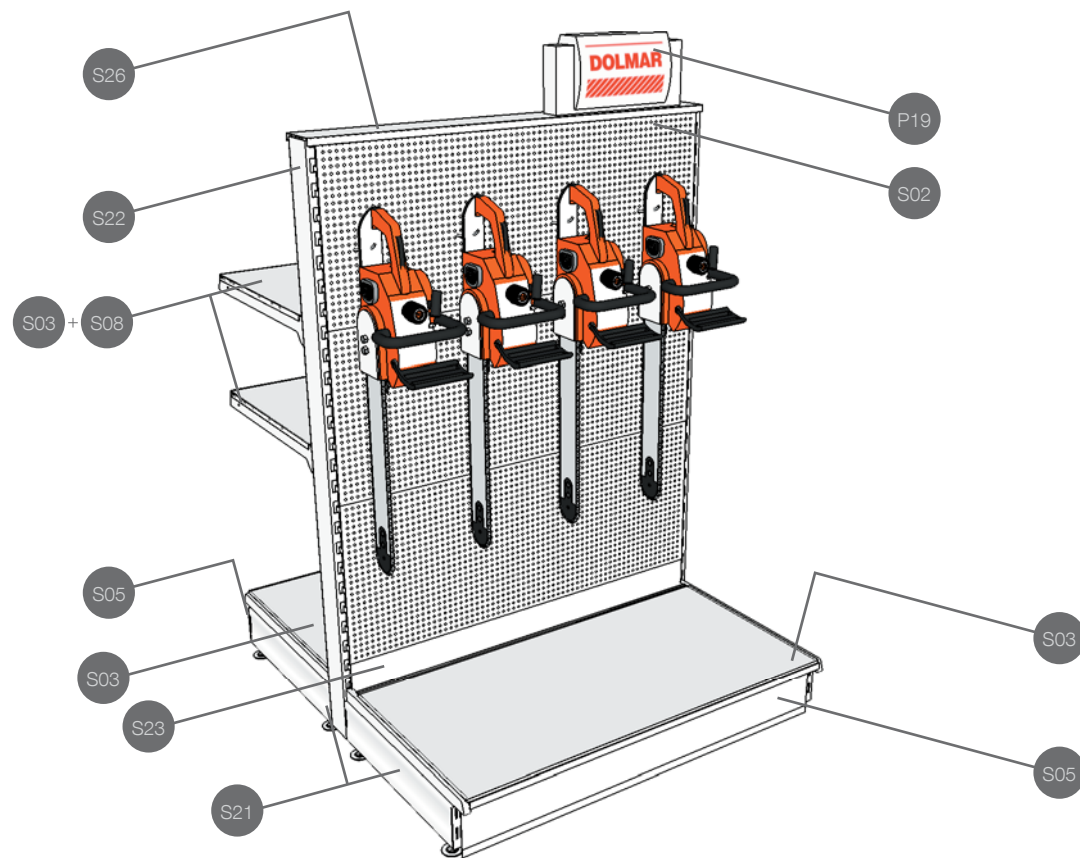

Popis	Počet (ks)	Materiál
S02 – panel zadný dierovaný 1000 × 400 mm	6	M01
S03 – police plechová 1000 × 500 mm, bez držiaku	4	M01
S05 – sokel – panel zadný hladký 1000 × 100 mm	2	M01
S08 – konzola vysoká 500 mm	4	M01
S21 – noha SU5 hl=500 mm	4	M01
S22 – stojina 80/30, v=1408 mm, vr. podpery stojky a rekt. skrutky M10	2	M01
S23 – panel zadný hladký 1000 × 100 mm	2	M01
S26 – plechový kryt gondoly pro modul 1000 mm	1	M01
P23 – Držiak nožníc na živé ploty do dierovaných zadných panelov 75 × 80 × 85 mm	4	M01
P19 – Logo Dolmar 360 × 100 × 170 mm + samolepka Dolmar 270 × 180 mm – voliteľné	1	M01



Priestorový regál DS2

Netto cena bez DPH pre predajcov DOLMAR: 149,00 €  
Cena bez DPH: 186,13 €



# priestorový regál

DS3

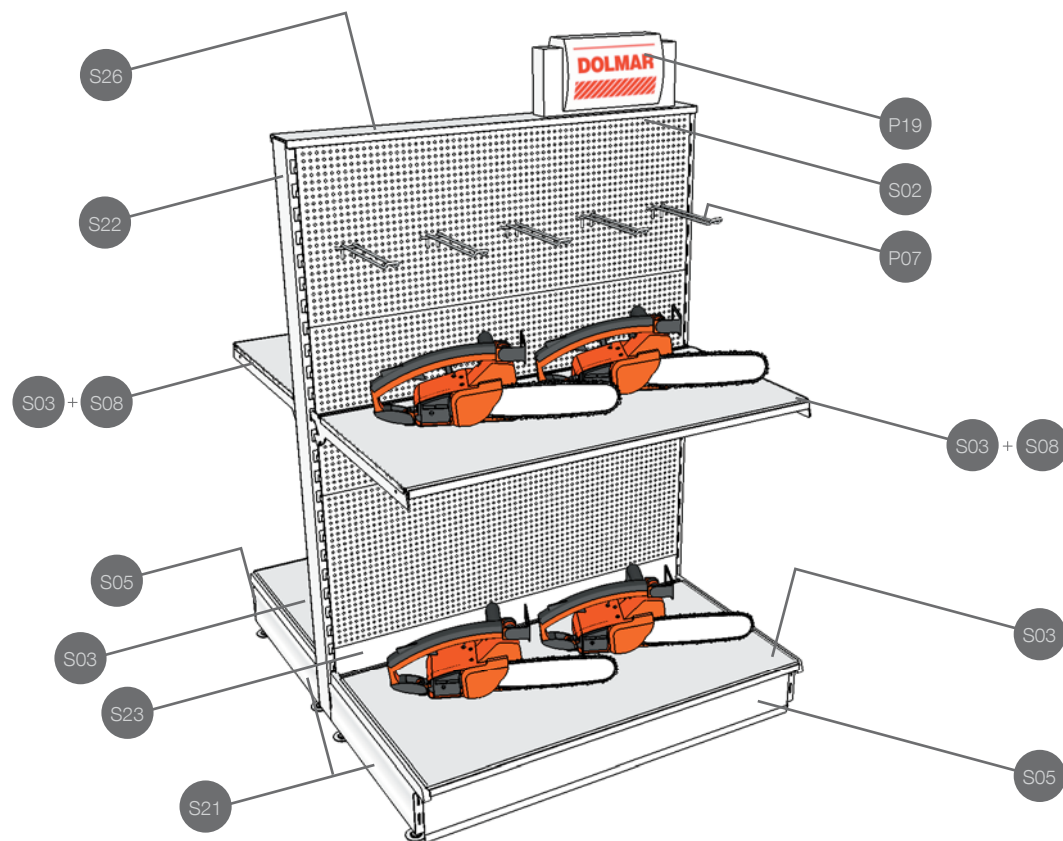

Popis	Počet (ks)	Materiál
S02 – panel zadný dierovaný 1000 × 400 mm	6	M01
S03 – police plechová 1000 × 500 mm, bez držiaku	4	M01
S05 – sokel – panel zadný hladký 1000 × 100 mm	2	M01
S08 – konzola vysoká 500 mm	4	M01
S21 – noha SU5 hl=500 mm	4	M01
S22 – stojina 80/30, v=1408 mm, vr. podpery stojky a rekt. skrutky M10	2	M01
S23 – panel zadný hladký 1000 × 100 mm	2	M01
S26 – plechový kryt gondoly pro modul 1000 mm	1	M01
P07 – háčik dvojité L200 / L250 do dierovaných zadných panelov	5	M01
P19 – Logo Dolmar 360 × 100 × 170 mm + samolepka Dolmar 270 × 180 mm – voliteľné	1	M01



Priestorový regál DS3

Netto cena bez DPH pre predajcov DOLMAR: 126,00 €  
Cena bez DPH: 156,75 €

# príslušenstvo

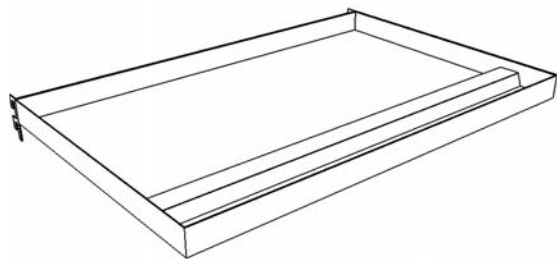

**P01A** – Zastrešenie š.1000 × hl.650 × v.55 mm, vrátane žiarivkového telesa OPPLÉ FISB 873, 21 W modul 1000  
Cena bez DPH: 75,60 €

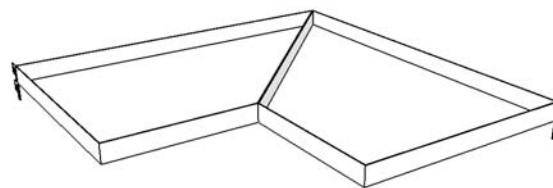

**P02L / P12P** – Zastrešenie kútové 45°- ľavej a pravej strany, bez žiarivkového telesa  
Cena bez DPH: 80,24 €

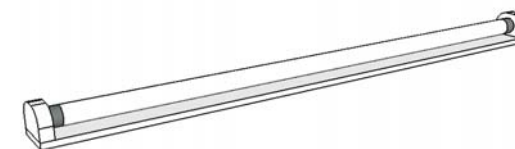

**P02** – Žiarivkové teleso OPPLÉ FISB 873, 21 W modul 1000  
Cena bez DPH: 12,18 €



**P03** – Flexo kábel s vidlicou 230V, trojžilový 3 × 0,75, čierny, dĺžka 3m  
Kábel prepojavací ohybný FISB 3PIN 40cm  
Cena bez DPH: 10,71 €



**P04** – Držiak na reťazové píly 500 × 500 × 400mm  
Cena bez DPH: 12,40 €

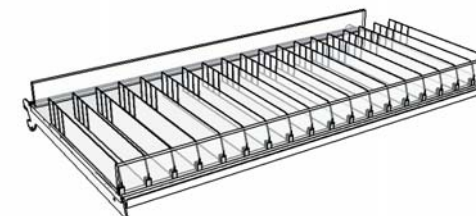
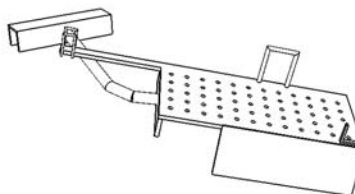

**P05** – Polica pre drobný tovar 1000 × 500 × 100mm  
Cena bez DPH: 89,63 €



**P06** – Háčik jednoduchý L200/L250 do dierovaných zadných panelov  
Cena bez DPH: 1,05/1,17 €

**P07** – Háčik dvojitý L200/L250 do dierovaných zadných panelov  
Cena bez DPH: 1,39/1,68 €



**P08** – Traverza na držiaky krovínorezov a reťazových píl 1000 × 60 × 110mm  
Cena bez DPH: 10,30 €



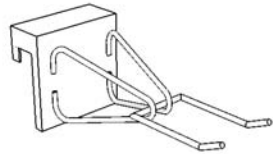

**P09** – Držiak na krovinorez 126 × 470 × 120mm  
Cena bez DPH: 7,22 €

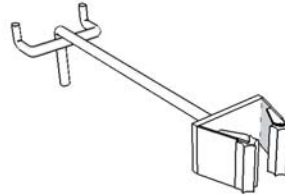

**P10** – Držiak 66 × 290 × 61mm  
do dierovaných zadných panelov  
Cena bez DPH: 6,30 €

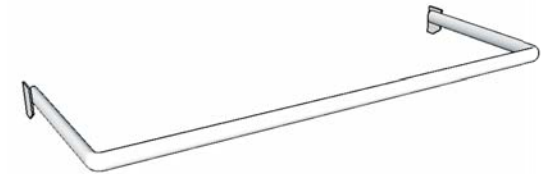

**P11** – Rám na oblečenie 1000 × 350mm  
s háčikmi do stojok  
Cena bez DPH: 12,40 €



**P13** – Záves 3000 × 2000 mm s motívom Dolmar  
Cena na vyžiadanie



**P14** – Držiak do dierovaných zadných panelov  
Cena bez DPH: 1,07 €



**P15** – Držiak do dierovaných zadných panelov  
Cena bez DPH: 1,24 €



**P16** – Cenovka magnetická – malá 50 × 40 mm  
Cena na vyžiadanie

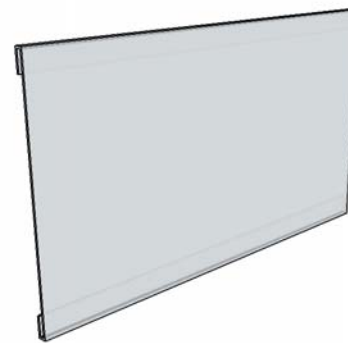

**P17** – Cenovka magnetická – veľká 210 × 115 mm  
Cena na vyžiadanie

# príslušenstvo

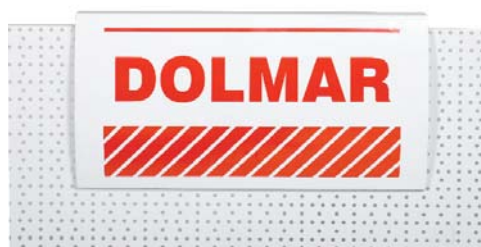

**P18** – Logo Dolmar 500 × 35 × 250 mm  
pre regál  
Cena bez DPH: 33,10 €



**P18A** – Logo Dolmar 500 × 35 × 250 mm  
pre regál  
Cena bez DPH: 33,10 €



**P19** – Logo Dolmar 360 × 100 × 170 mm  
pre priestorový regál  
Cena bez DPH: 33,10 €



**P20** – Ramičko šatníkové – Dolmar  
Cena na vyžiadanie

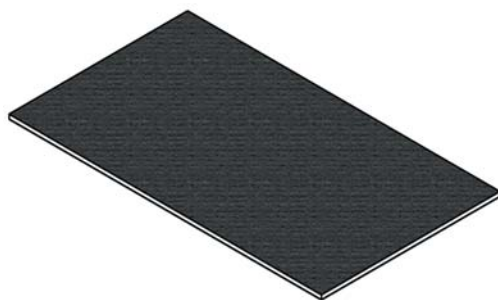

**P21** – Gumová podložka 1000 × 700 mm  
Cena bez DPH: 36,10 €

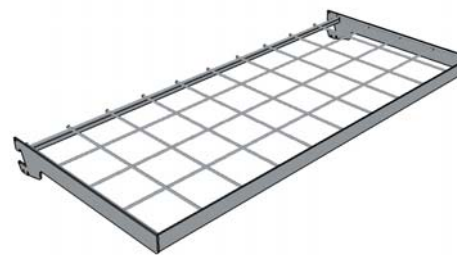

**P22** – Polica rámová 1000 × 400 mm  
s drôteným rastrom  
Cena bez DPH: 25,53 €

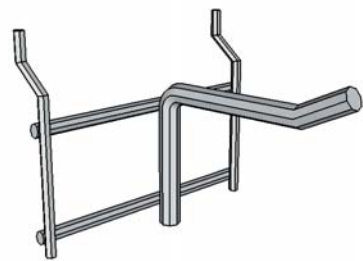

**P23** – Držiak nožníc na živé ploty do dierovaných zadných panelov 75 × 80 × 85 mm  
Cena bez DPH: 4,51 €

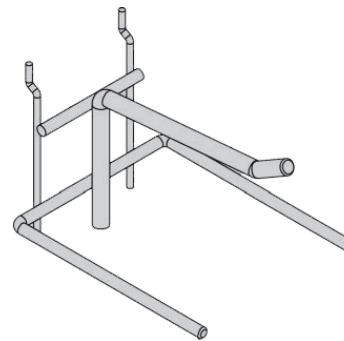

**P24** – Držiak na záhradné nožnice  
Cena bez DPH: 5,83 €

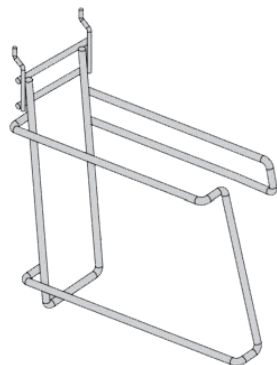

**P25** – Držiak na sekery, veľký  
Cena bez DPH: 6,65 €

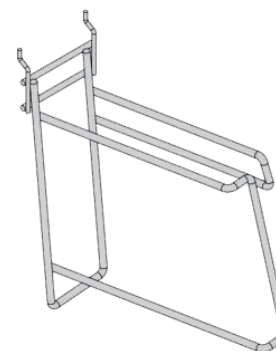

**P26** – Držiak na sekery, malý  
Cena bez DPH: 6,59 €

# príslušenstvo

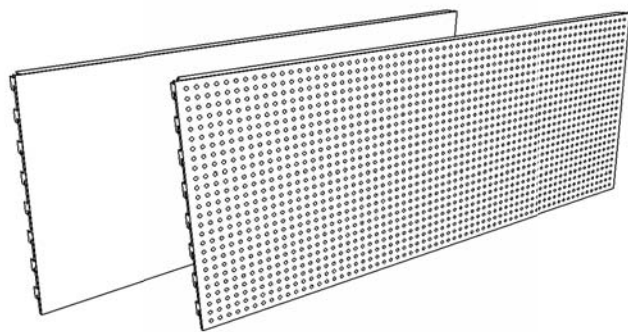

**S01** – Panel zadný hladký 1000 × 400 mm

Cena bez DPH: 7,53 €

**S02** – Panel zadný dierovaný 1000 × 400 mm

Cena bez DPH: 8,19 €

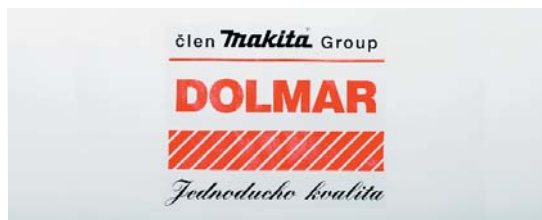

**S01** – Panel zadný hladký 1000 × 400 mm

s logom Dolmar

Cena bez DPH: 12,60 €



**S01A** – Panel zadný hladký 1000 × 400 mm

s motívom Dolmar

Cena bez DPH: 12,60 €



**S01B** – Panel zadný hladký 1000 × 400 mm

s motívom Dolmar

Cena bez DPH: 12,60 €



**S01C** – Panel zadný hladký 1000 × 400 mm

s motívom Dolmar

Cena bez DPH: 12,60 €



**S01D** – Panel zadný hladký 1000 × 400 mm

s motívom Dolmar

Cena bez DPH: 12,60 €



**S01E** – Panel zadný hladký 1000 × 400 mm

s motívom Dolmar

Cena bez DPH: 12,60 €

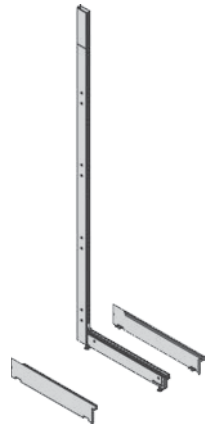

**N01** – Stojka na regál  
Cena bez DPH: 35,80 €

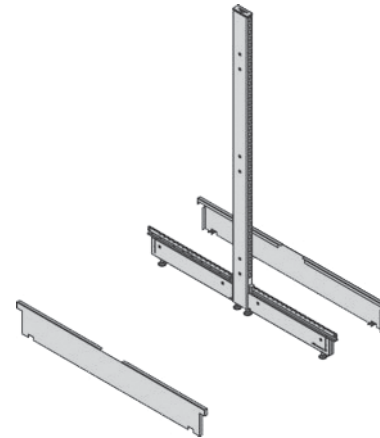

**N02** – Stojka na priestorový regál  
Cena bez DPH: 45,77 €



# stojan na kosačky

---





stojan na kosačky

Netto cena bez DPH pre predajcov DOLMAR: 480,00 €  
Cena bez DPH: 673,63 €



# pultové moduly



**PU01** – Pokladničný pult 1100 × 750 × 1200 mm  
Netto cena bez DPH pre predajcov DOLMAR: 357,00 €  
Cena bez DPH: 510,00 €



**PU02** – Pokladničný pult 750 × 575 × 1200 mm  
s uzamykateľnou zásuvkou  
Netto cena bez DPH pre predajcov DOLMAR: 375,00 €  
Cena bez DPH: 375,00 €



**PU03** – Pokladničný pult 750 × 575 × 1200 mm  
Netto cena bez DPH pre predajcov DOLMAR: 212,00 €  
Cena bez DPH: 212,00 €



**PU04** – Pokladničný pult 750 × 575 × 1200 mm  
s policami na oboch stranách  
Netto cena bez DPH pre predajcov DOLMAR: 234,00 €  
Cena bez DPH: 234,00 €



**PU05** – Doplnkový pult 750 × 575 × 1050 mm  
s uzamykateľnou zásuvkou  
Netto cena bez DPH pre predajcov DOLMAR: 270,00 €  
Cena bez DPH: 270,00 €



**PU06** – Doplnkový pult 750 × 575 × 1050 mm  
Netto cena bez DPH pre predajcov DOLMAR: 159,00 €  
Cena bez DPH: 159,00 €

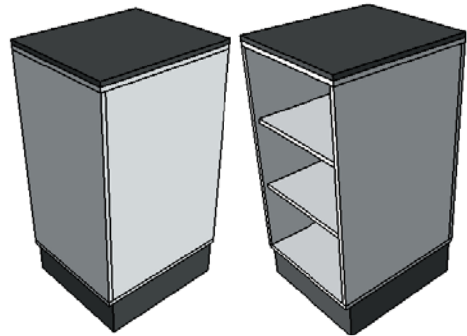

**PU07** – Doplnkový pult 500 × 575 × 1050 mm  
**Netto cena bez DPH pre predajcov DOLMAR: 135,00 €**  
 Cena bez DPH: 135,00 €

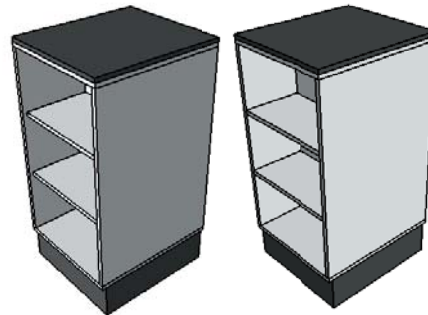

**PU08** – Doplnkový pult 500 × 575 × 1050 mm  
 s policami na oboch stranách  
**Netto cena bez DPH pre predajcov DOLMAR: 183,00 €**  
 Cena bez DPH: 183,00 €

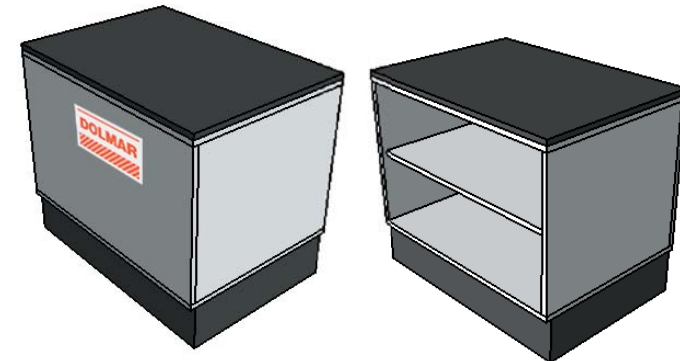

**PU09** – Výdajný pult 800 × 575 × 700 mm  
 s gumovou povrchovou úpravou  
**Netto cena bez DPH pre predajcov DOLMAR: 157,00 €**  
 Cena bez DPH: 157,00 €



**PU10** – Presklený pult 1050 × 575 × 1050 mm  
 so sklenenými policami a vnútorným podsvietením  
**Netto cena bez DPH pre predajcov DOLMAR: 375,00 €**  
 Cena bez DPH: 375,00 €



**PU11** – Rohový pult 575 × 575 × 1050 mm  
**Netto cena bez DPH pre predajcov DOLMAR: 183,00 €**  
 Cena bez DPH: 183,00 €

# ÚPLNÝ KATALÓG PRÍSLUŠENSTVA DOLMAR 2017/2018

**Makita s.r.o.**

Jegorovova 35, 974 01 Banská Bystrica  
Tel: 048 / 416 17 72, Fax: 048 / 416 17 69  
[www.dolmar.sk](http://www.dolmar.sk)

člen *Makita* Group

**DOLMAR**



*Jednoduchá kvalita*

